

PEUGEOT 3008 ('09-)

-
- ✦ **Enganche fabricado por URBENI adaptable a la marca del vehículo.**
 - ✦ **Towbar made by URBENI adaptable to the brand of the vehicle.**
 - ✦ **Attelage fabriqué par URBENI adaptable à la marque de ce véhicule.**
 - ✦ **Für dieses Fahrzeug angepasst und hergestellt durch URBENI**
 - ✦ **Dispositivo de traino URBENI adeguato alla marca di questo veicolo.**

URBENI le ofrece una garantía del producto por un periodo de 2 años desde la fecha de entrega, conforme lo dispuesto en la directiva 1999/44/CE y la ley 23/2003, esta garantía está limitada a reemplazar el producto defectuoso y en ningún caso se extenderá a daños o perjuicios consecuenciales.

THE URBENI's products have a warranty period of 2 years after the delivery date, conform to the standard 1999/44/CE, this warranty is limited to the replacement of the defective products, and it will not never cover any derivate damages.

Les produits d'URBENI ont une garantie de 2 ans depuis la date de livraison ce qui est conforme à la Normative Européenne 1999/44CE. Cette garantie inclue de remplacer le produit défectueux, mais en aucun cas les dommages ou préjudices conséquents

URBENI gewährt eine Garantie von einen 2 Jahre in ordnung nach dem Fertigungsnorm. Der Hersteller behält sich das Recht vor die schadhafte Ware zu repaieren oder zu ersetzen und in keinem Fall übernimmt er Folgekosten für Schäden an Dritten.

Bemerkung: Für einen Mangel am Produkt, der durch den Fahrzeughalter oder eine andere. Person aufgrund unsachgemäßer Benutzung verursacht wurde, übernimmt Urbeni keine Haftung. Alle befestigungsschrauben der KmH nach ca. 1000 Anhänger-Km und bei jeder Fahrzeuginspektion gemäss den angegebenen Anziehdrehmomenten nachziehen

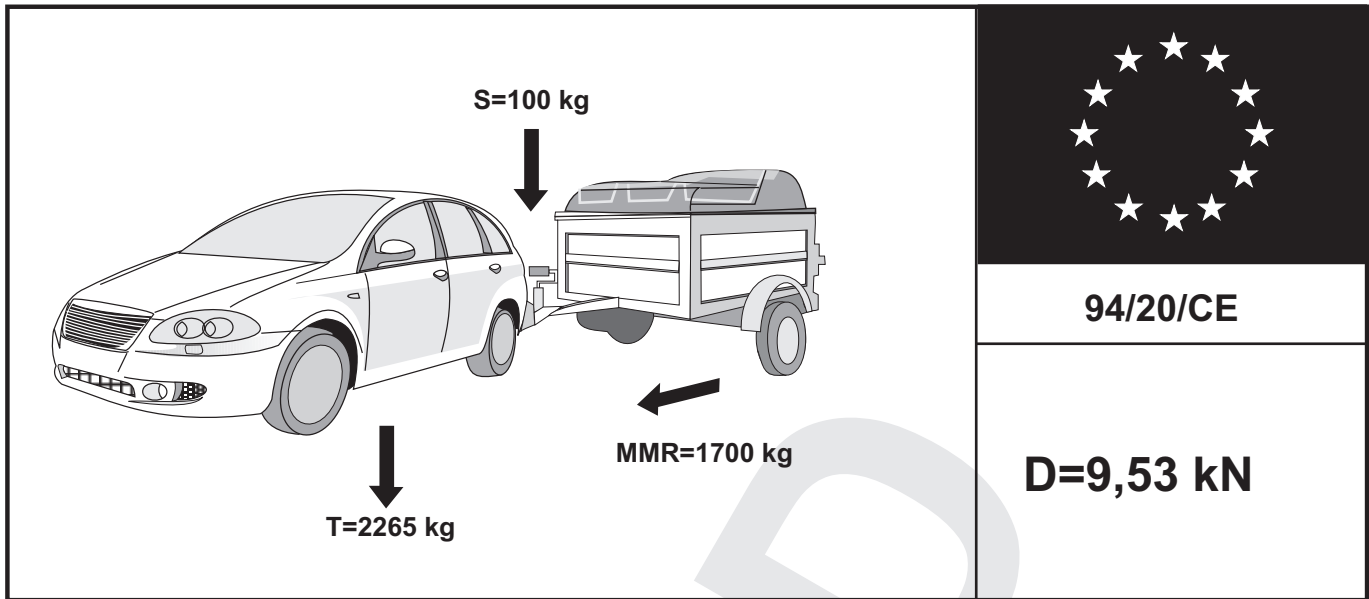

$g = 9,81 \text{ m/s}^2$

$$D = \frac{T \cdot R}{1000 \cdot (T + R)} \cdot g \quad T = \frac{R \cdot D \cdot 1000}{(g \cdot R) - (1000 \cdot D)} \quad R = \frac{R \cdot D \cdot 1000}{(g \cdot T) - (1000 \cdot D)}$$

kN kg kg

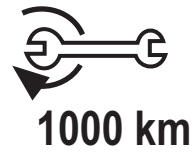
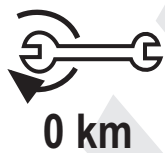

	M8	M10	M12	M14	M16
N · m	23	50	80	135	200

$\varnothing = 50 \text{ mm}$ ✓

$\varnothing < 49 \text{ mm}$ ✗

URBENi

100 kg

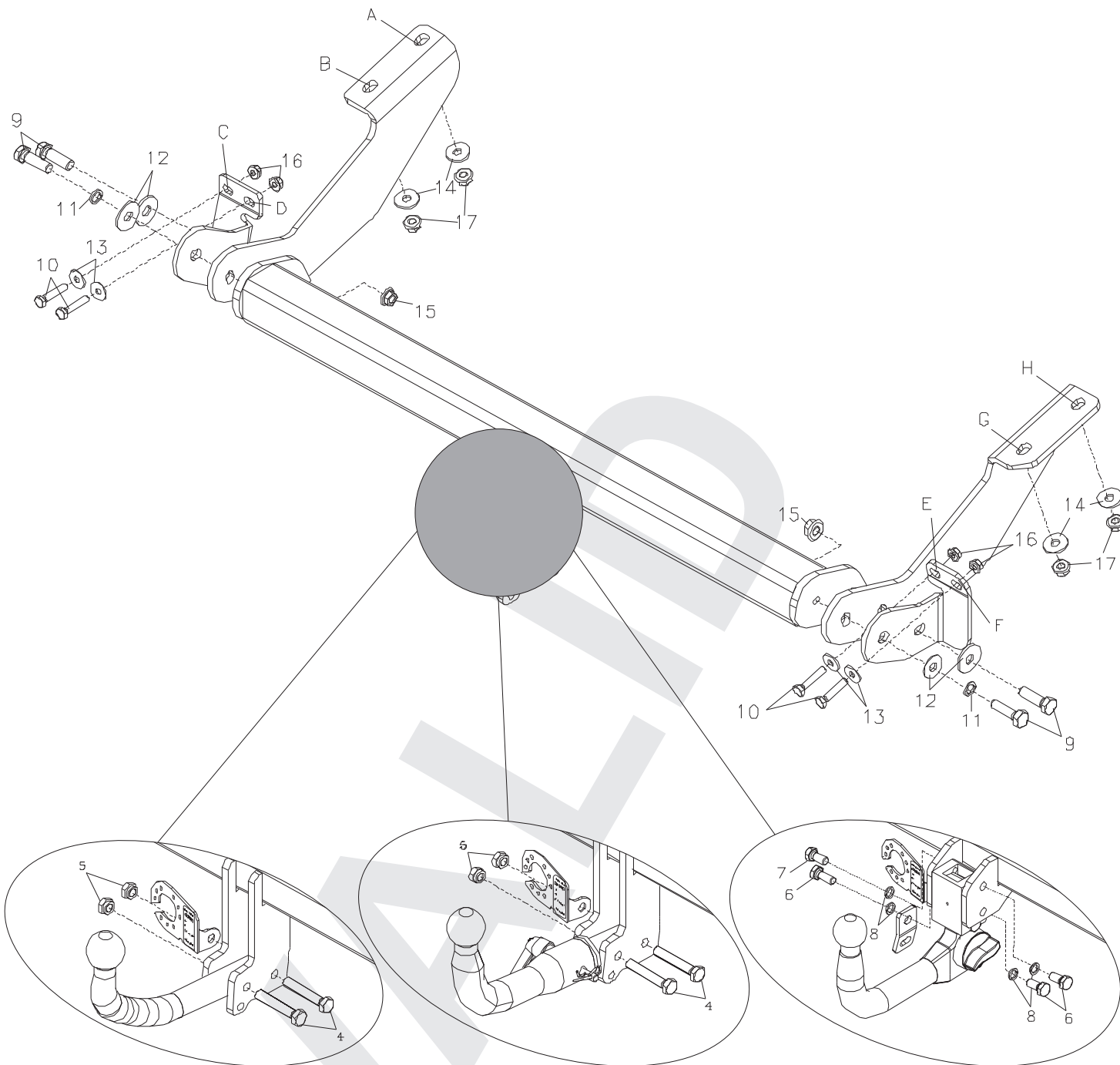

REF:02553

URBENi

CLASS **A50-X**

APPROVAL NUMBER
E13 55R-01 3508

TYPE **P 029**

D-VALUE
 D **9,53** kN

MAX.VERT.LOAD.
 S **100** kg

www.urbeni.com
 MADE IN SPAIN

REF:22553

URBENi

CLASS **A50-X**

APPROVAL NUMBER
E13 55R-01 3509

TYPE **P 030A**

D-VALUE
 D **9,53** kN

MAX.VERT.LOAD.
 S **100** kg

www.urbeni.com
 MADE IN SPAIN

REF:82553

URBENi

CLASS **A50-X**













APPROVAL NUMBER
E13 55R-01 3509

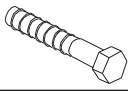

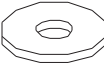

TYPE **P 030B**

D-VALUE
 D **9,53** kN

MAX.VERT.LOAD.
 S **100** kg

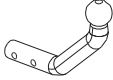
www.urbeni.com
 MADE IN SPAIN

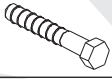
N°		Q	
1		1	
2		1	
3		1	
9		4	M12x40 DIN 933
10		4	M8x90 DIN 931
11		2	M12 DIN 7980
12		4	M12 DIN 125
13		4	M8 DIN 125
14		4	M10 DIN 9021
15		2	M12 DIN 6923
16		4	M8 DIN 6923
17		4	M10 DIN 6923

			
4		2	M12x80 DIN 931
5		2	M12 DIN 985

			
6		3	M12x25 DIN 933
7		1	M12x30 DIN 933
8		4	M12 DIN 7980

1

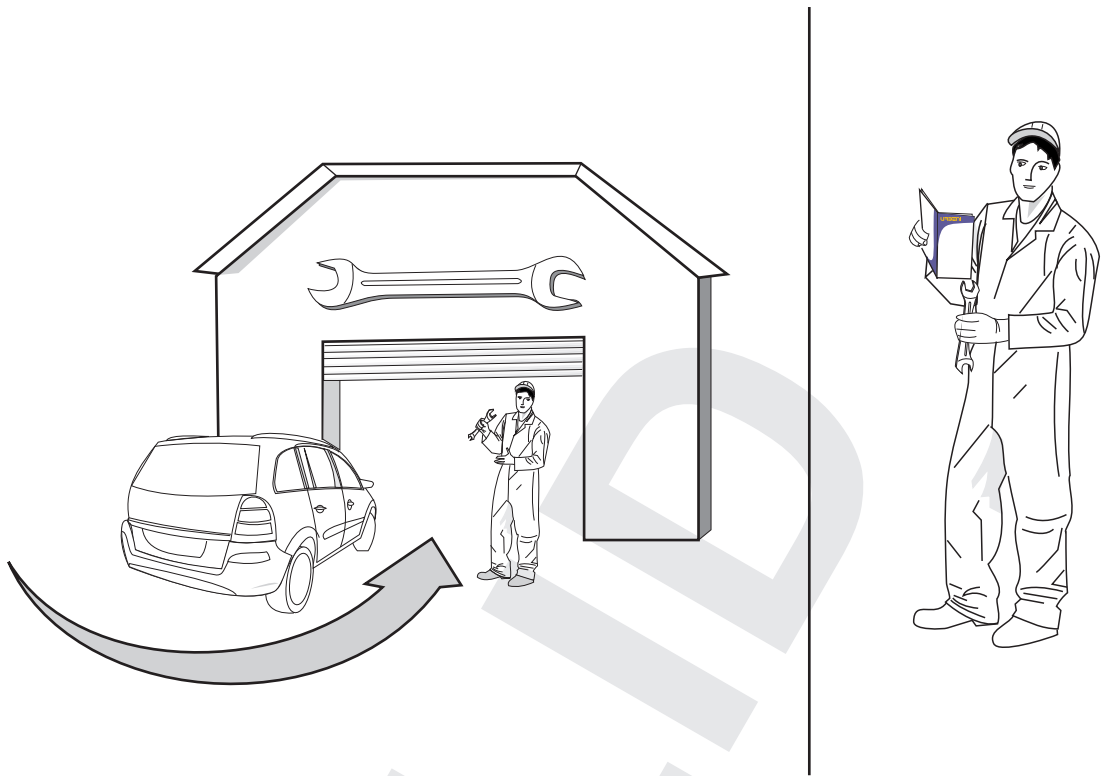

2



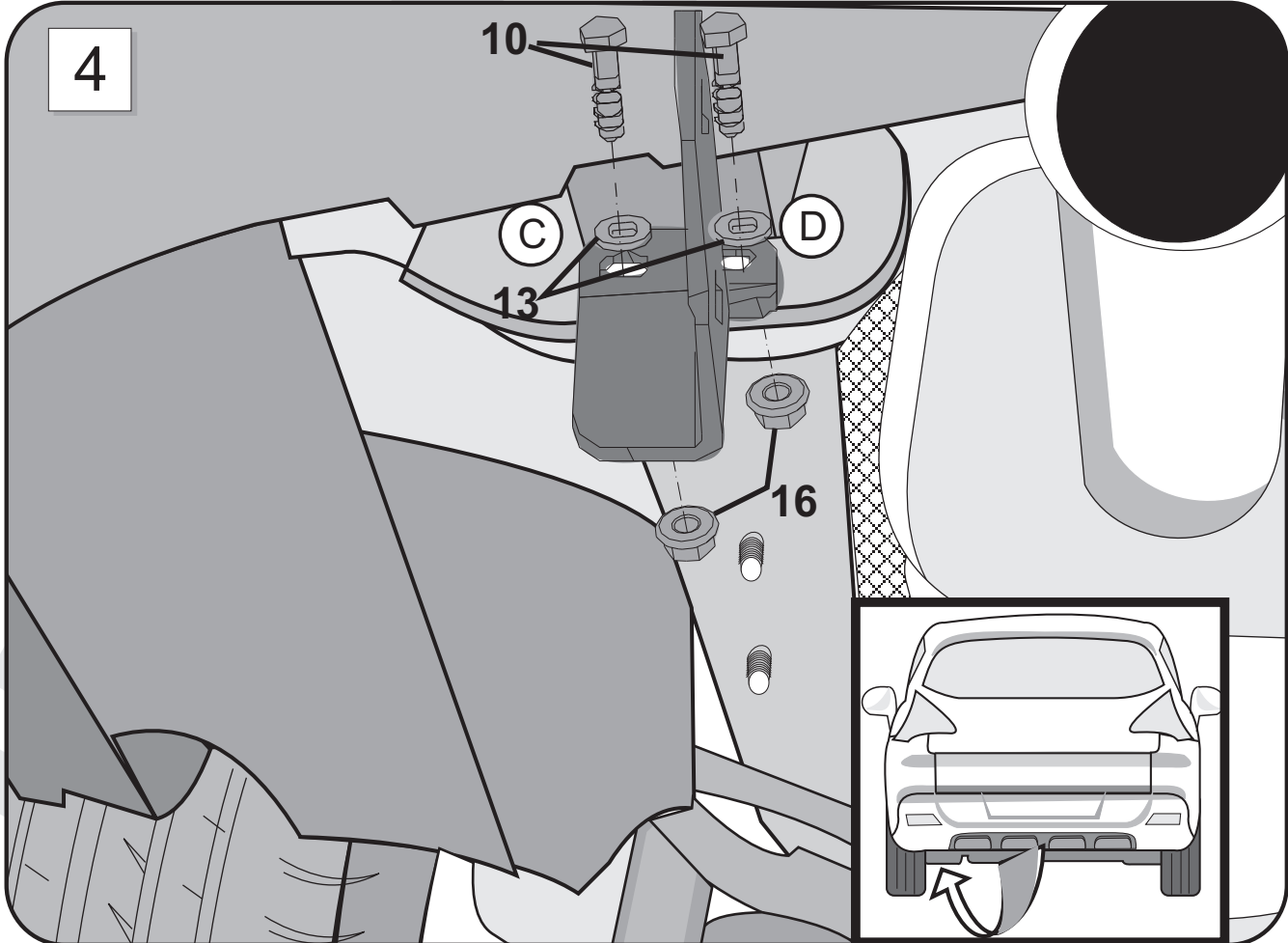
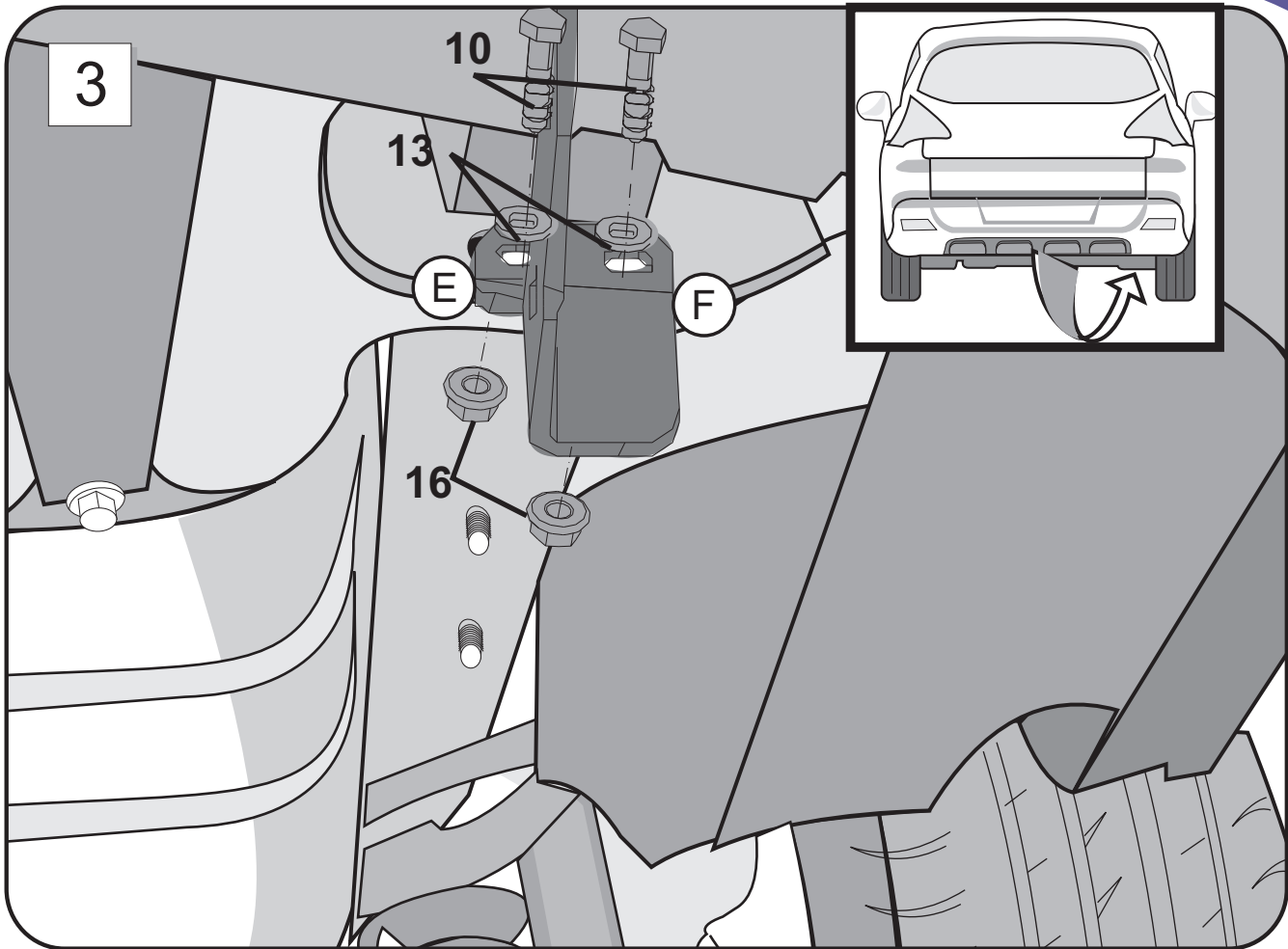

5



6

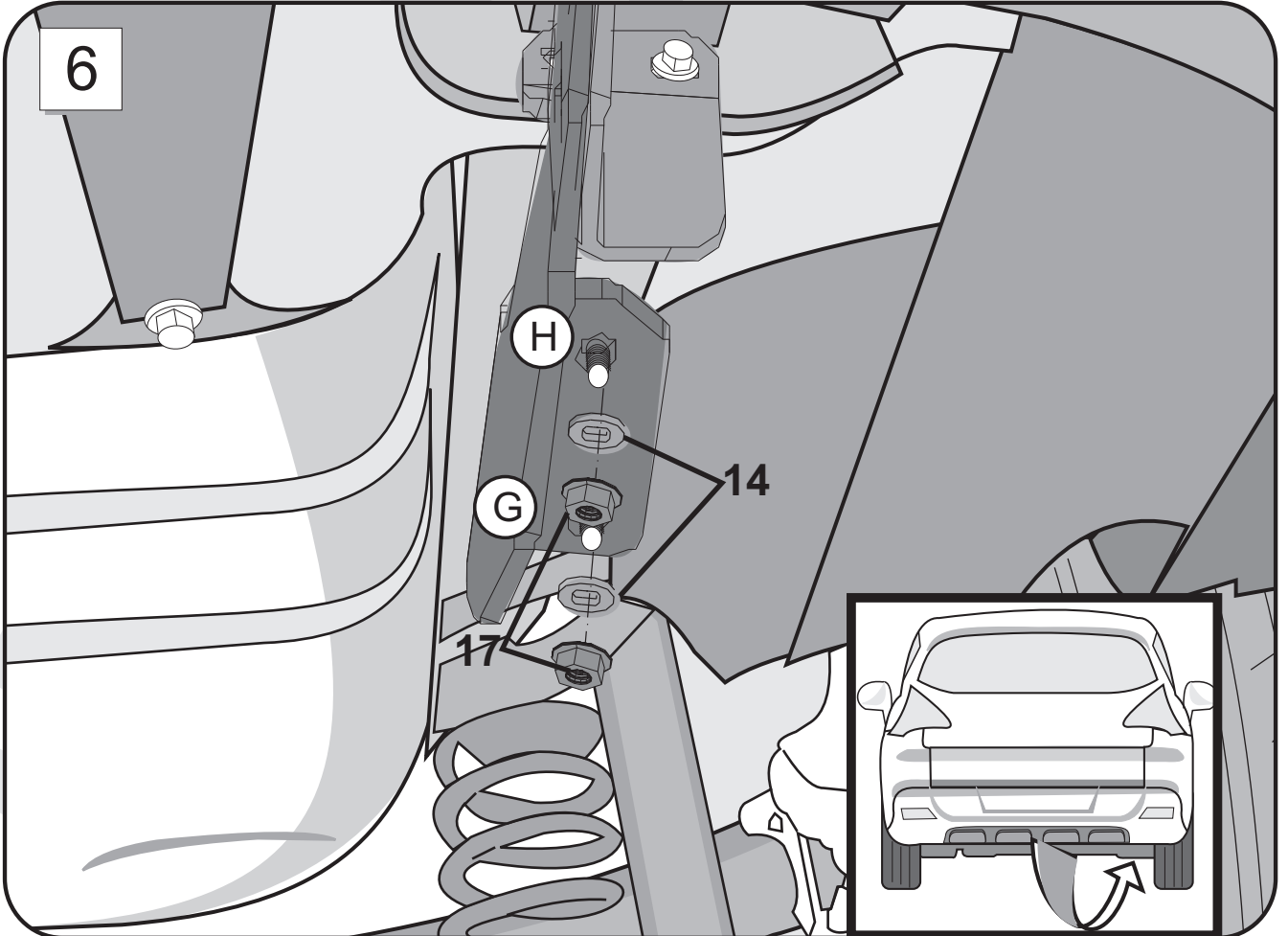

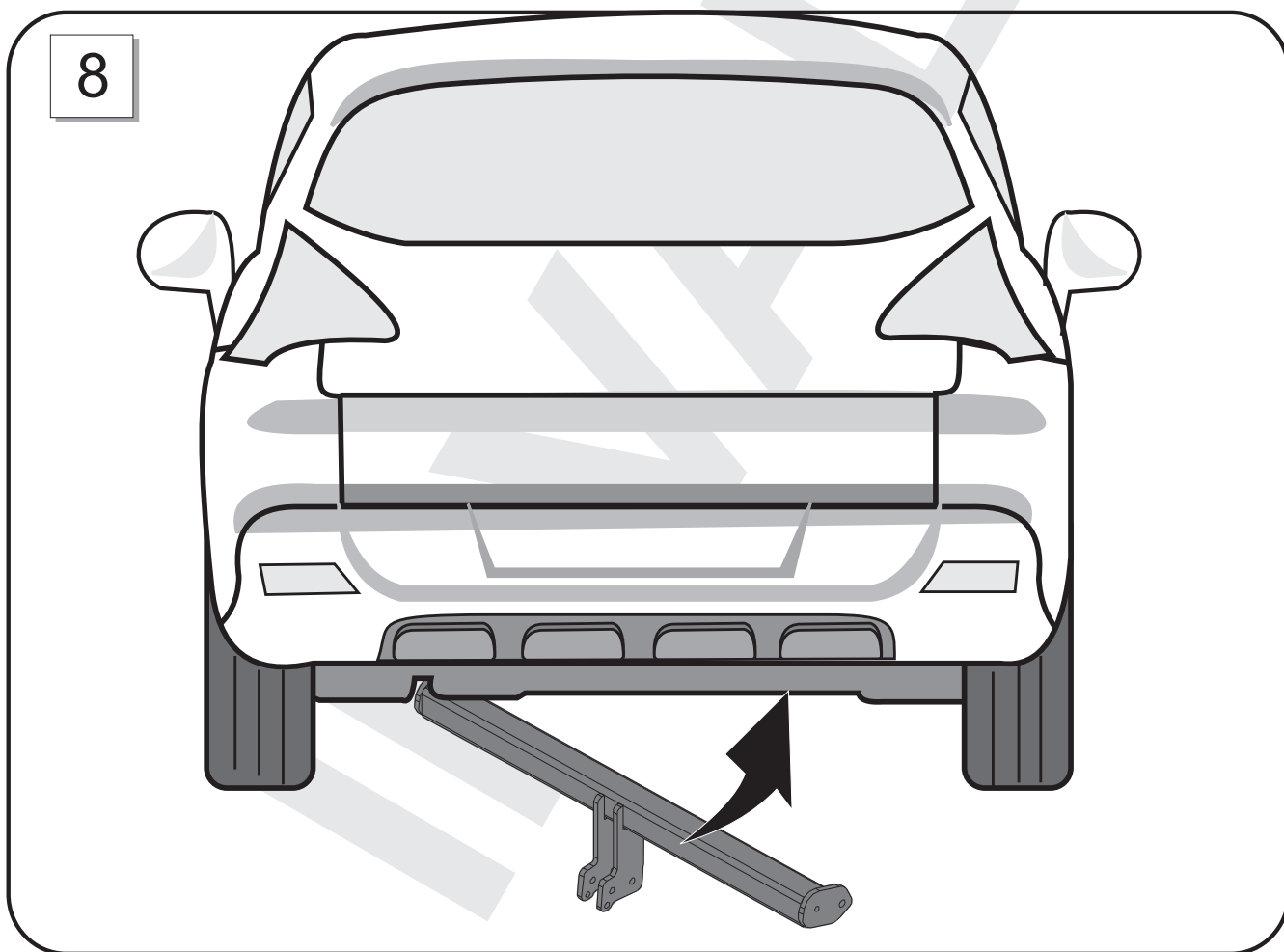
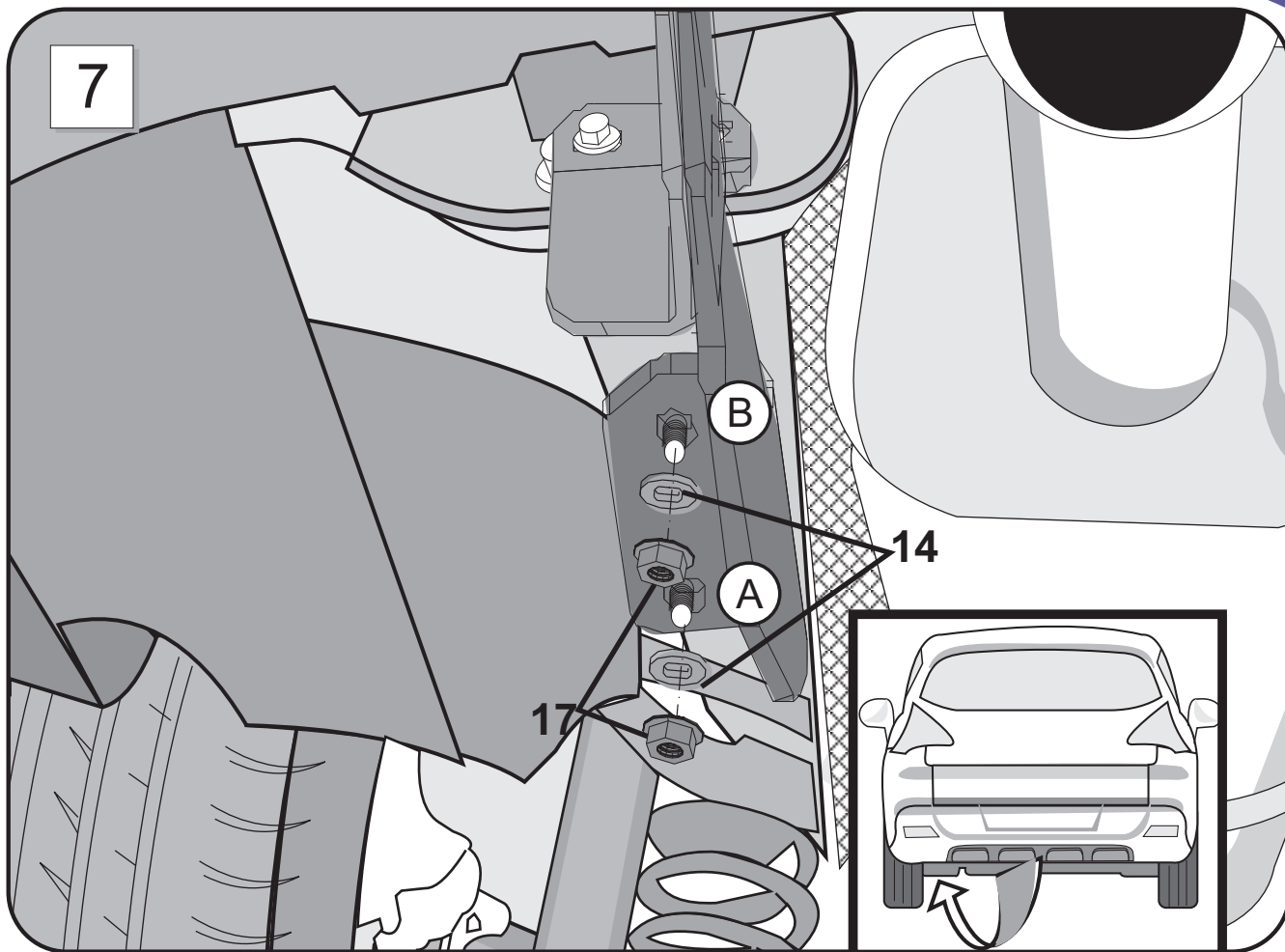

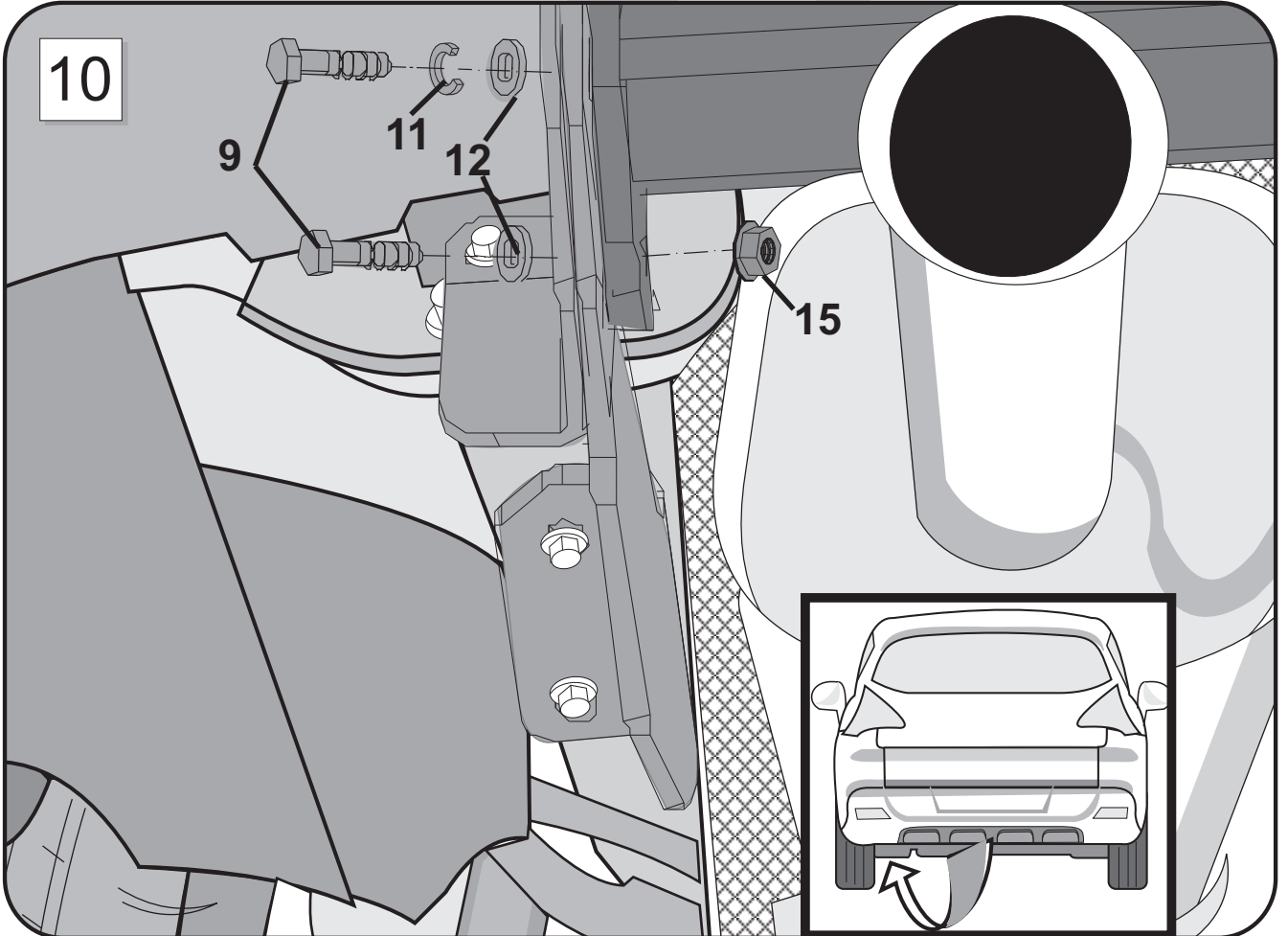
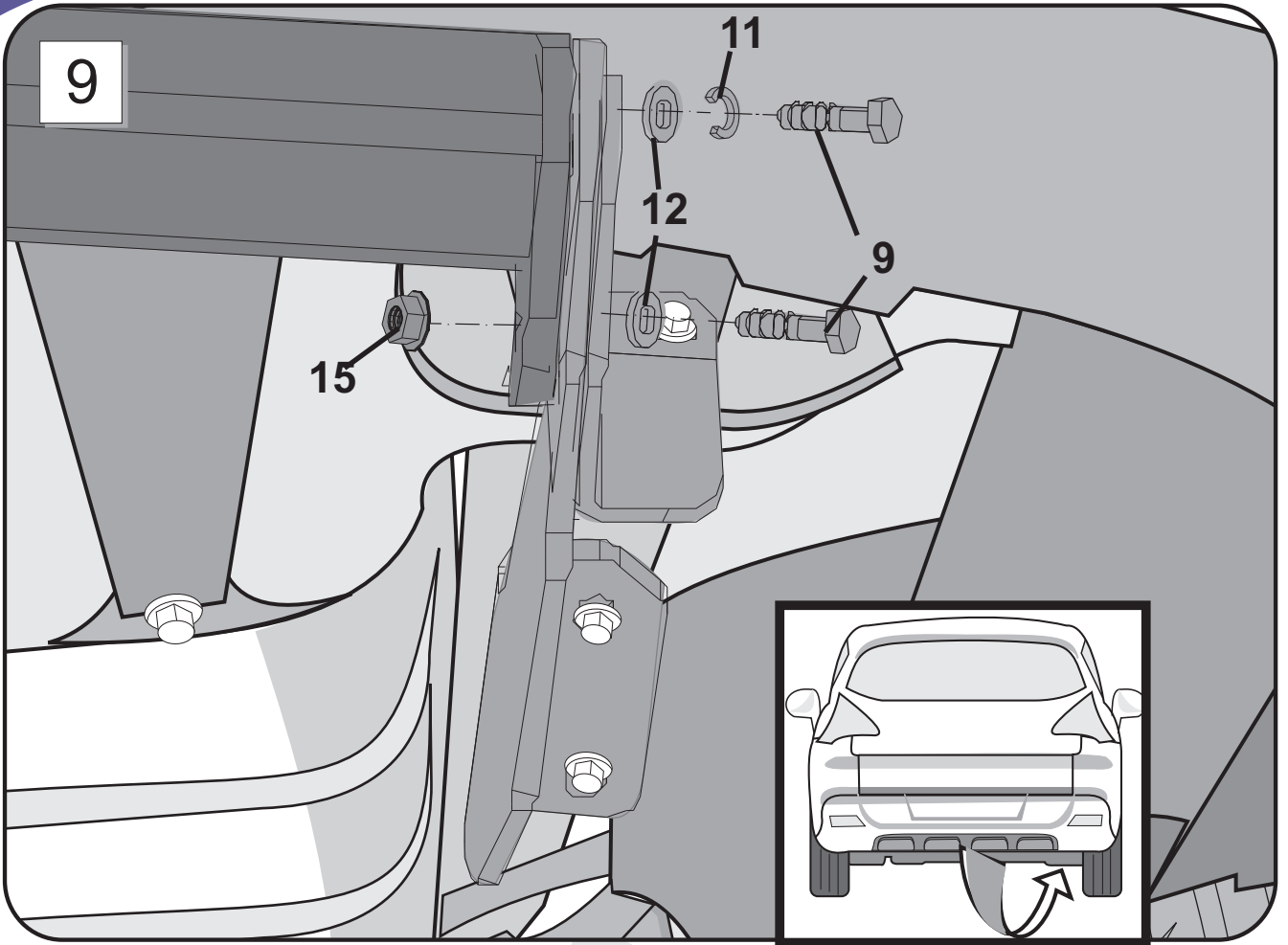

11

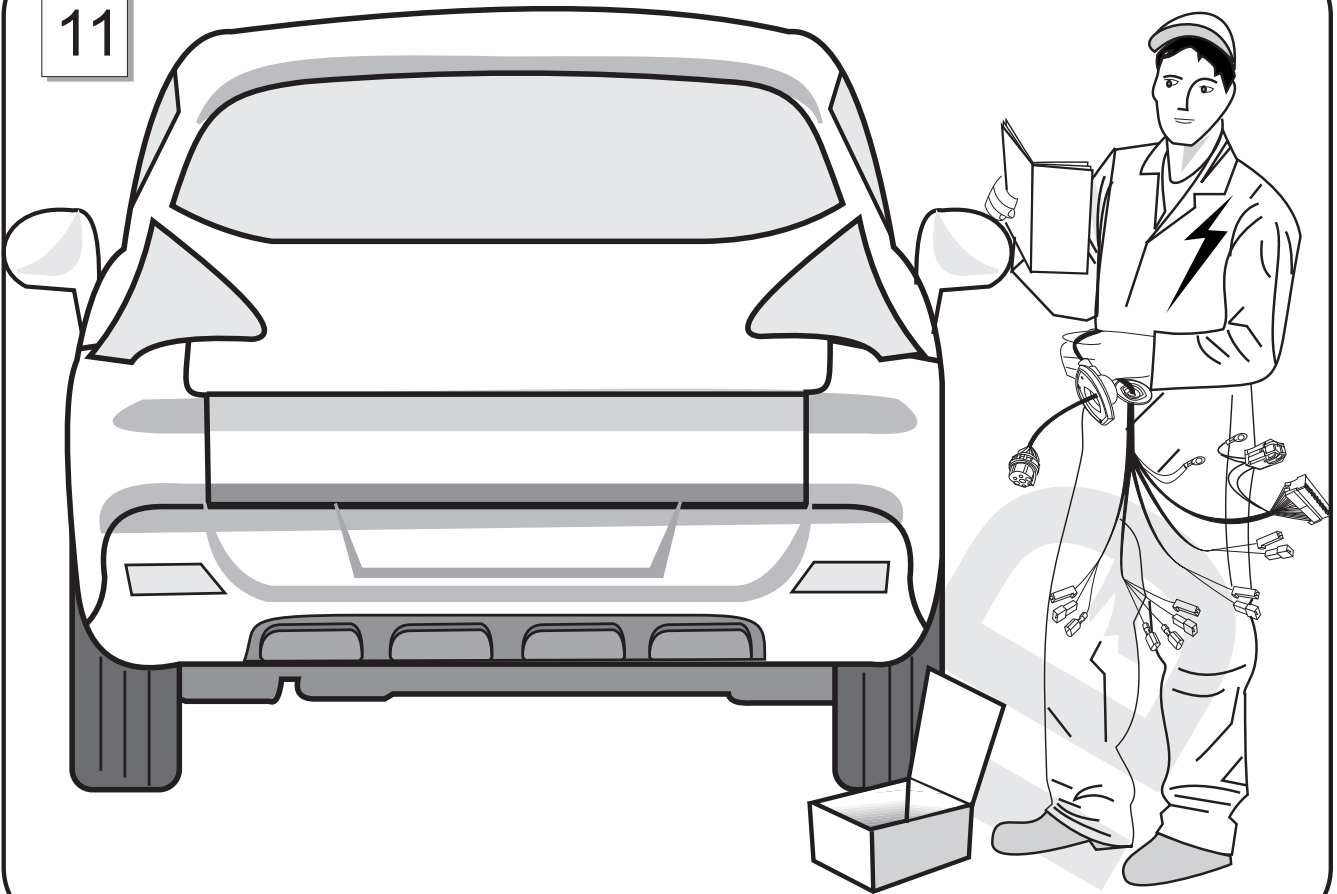

12

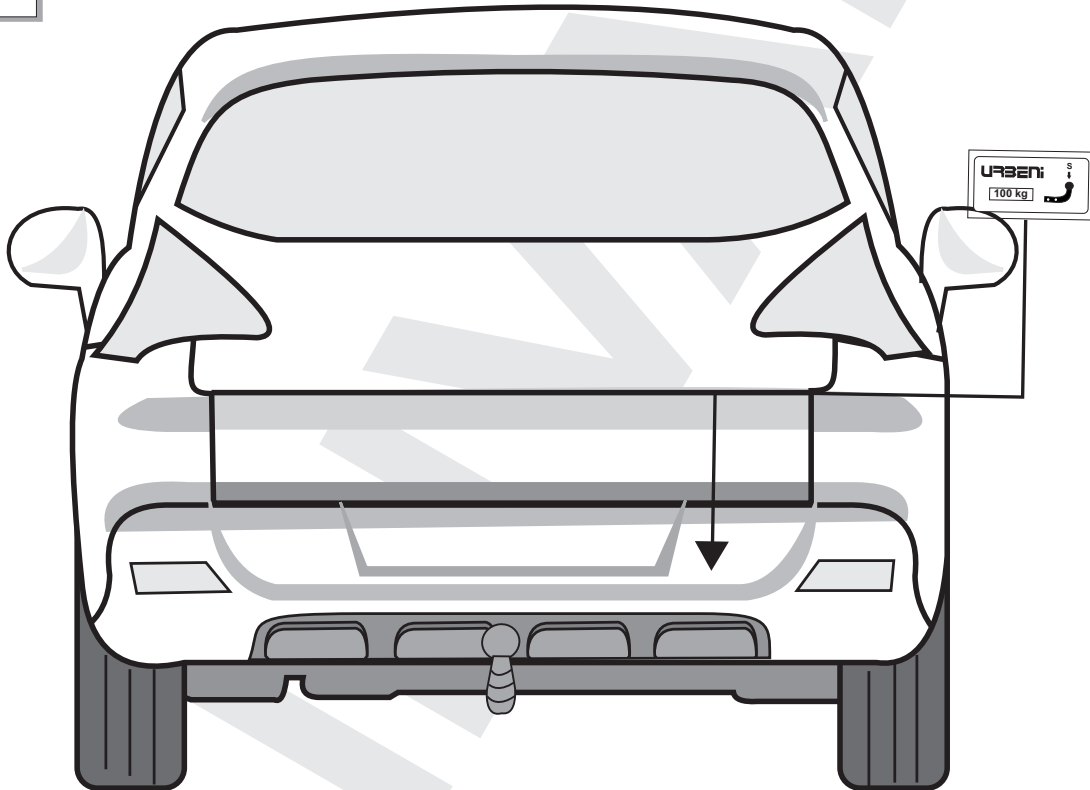

13

E I



- NL
- GR
- IRL
- DK
- GB
- F
- D
- CZ

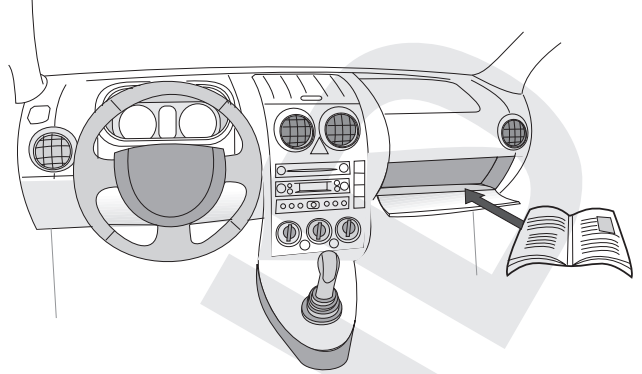
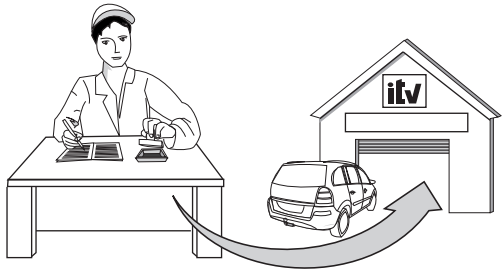

INVALID

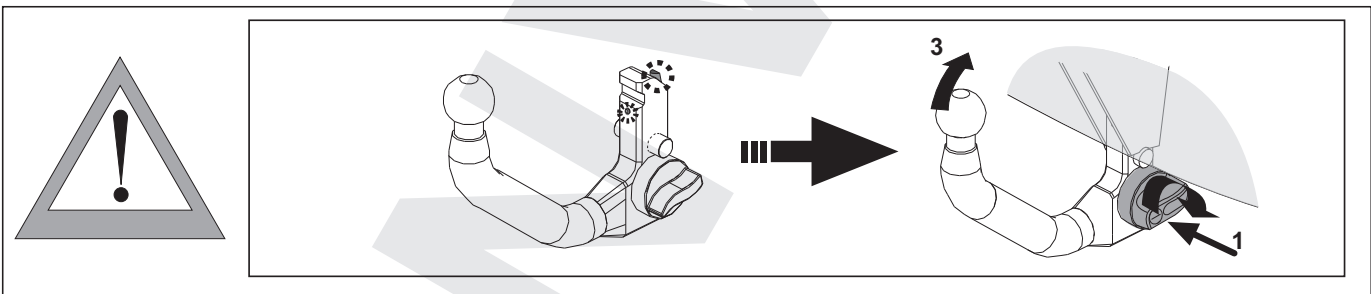
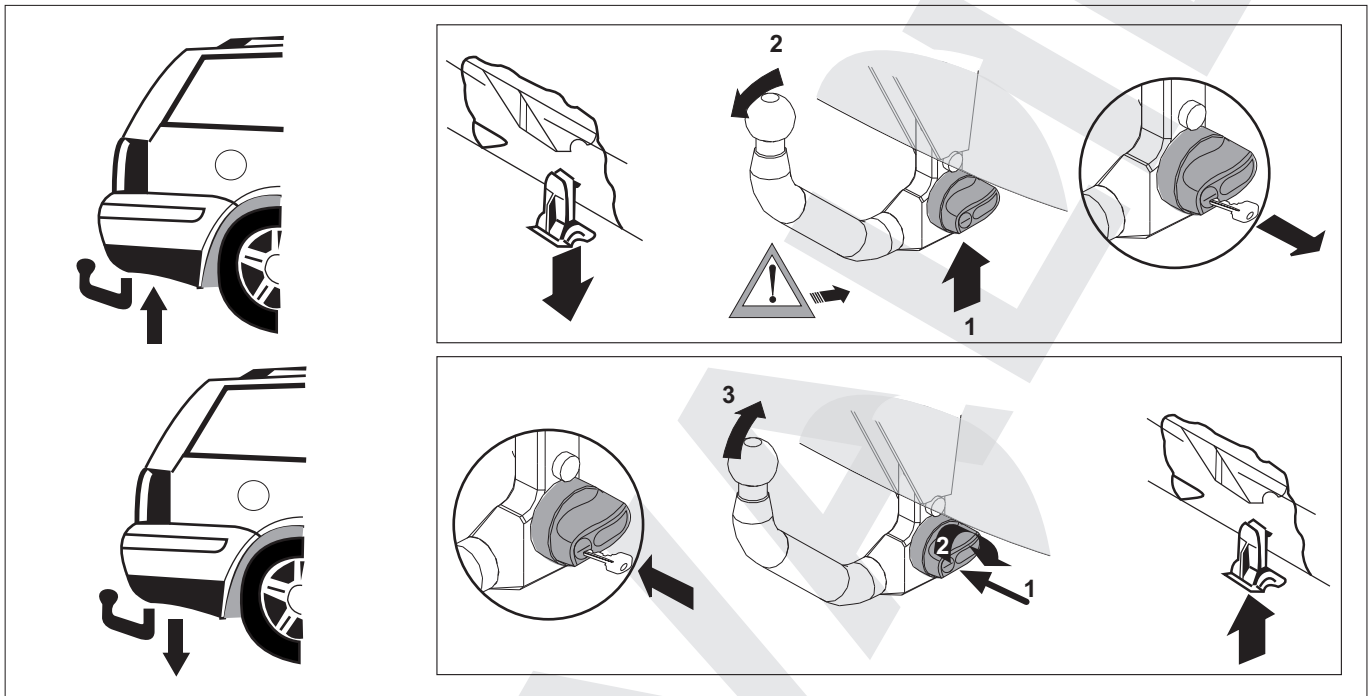
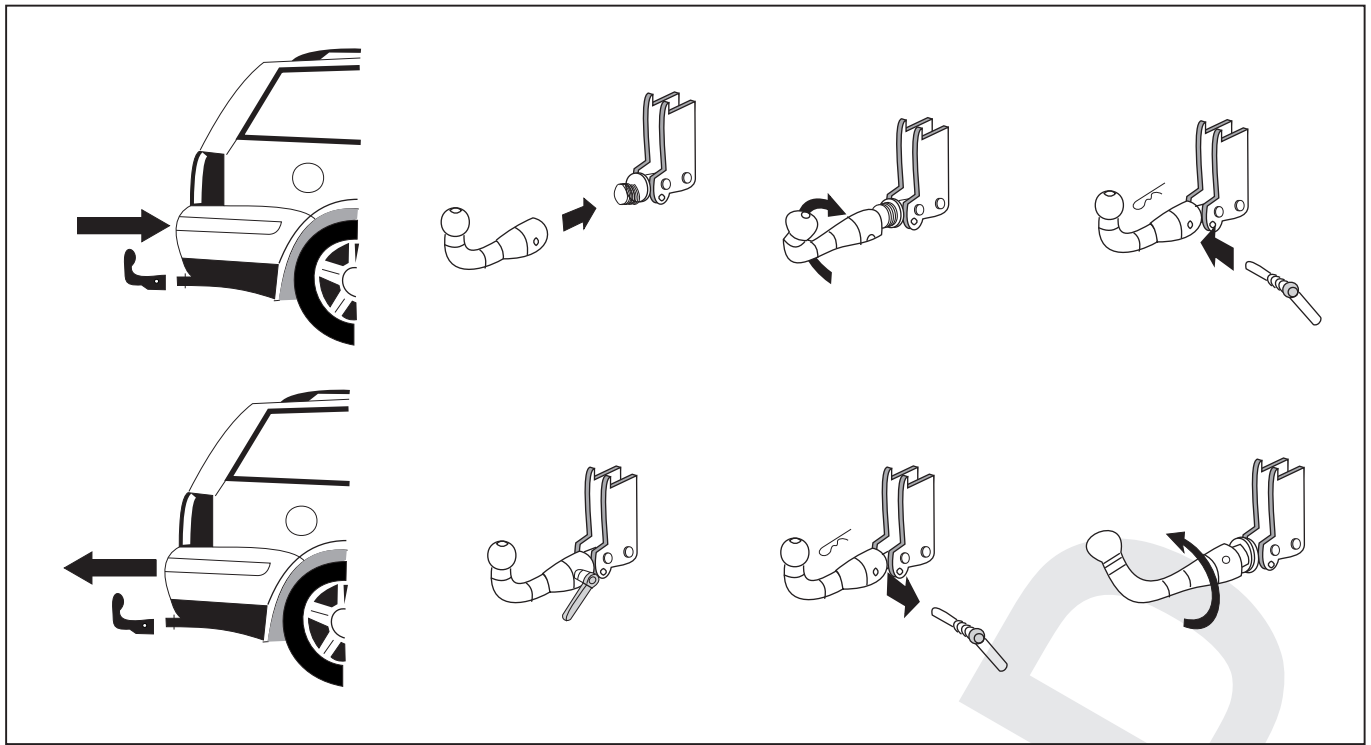

INVALID



LE GOUVERNEMENT
DU GRAND-DUCHE DE LUXEMBOURG

Ministère des Transports

L-2938 Luxembourg

SOCIETE NATIONALE DE
CERTIFICATION ET D'HOMOLOGATION



L-5201 Sandweiler

Registre de Commerce: B 27180

REFERENCE : E13*55R00*55R01*3508*00

ANNEXES : -Rapport Technique
-Fiche de Renseignements du constructeur

Sandweiler, le 26 june 2012

Certificat de réception CE par type EC Type-Approval Certificate

Communication concernant¹
Communication concerning¹

- la réception
the type approval
- l'extension de la réception
the extension of type approval
- le refus de la réception
the refusal of type approval
- le retrait de la réception
the withdrawal of type approval

d'un type d'élément de construction visé par la directive 94/20/CE
of a type of a component with regard to Directive 94/20/EC

Numéro de réception² : E13*55R00*55R01*3508*00
Type-approval number² :

Motif de l'extension : Not applicable
Reason of extension :

SECTION I SECTION I

- 0.1. **Marque (raison sociale du constructeur) :** URBENI
Make (trade name of manufacturer) :
- 0.2. **Type :** P 029
Type :
- Description(s) commerciale(s) générale(s) :** Undetachable coupling ball
General commercial description(s) :
- Version(s)/Variante(s) :** Not applicable
Version(s)/Variant(s) :



LE GOUVERNEMENT
DU GRAND-DUCHE DE LUXEMBOURG

Ministère des Transports

L-2938 Luxembourg

SOCIETE NATIONALE DE
CERTIFICATION ET D'HOMOLOGATION



L-5201 Sandweiler
Registre de Commerce: B 27180

REFERENCE : E13*55R00*55R01*3509*00

ANNEXES : -Rapport Technique
-Fiche de Renseignements du constructeur

Sandweiler, le 26 juin 2012

Certificat de réception CE par type EC Type-Approval Certificate

Communication concernant ¹
Communication concerning¹

- la réception
the type approval
- l'extension de la réception
the extension of type approval
- le refus de la réception
the refusal of type approval
- le retrait de la réception
the withdrawal of type approval

d'un type d'élément de construction visé par la directive 94/20/CE
of a type of a component with regard to Directive 94/20/EC

Numéro de réception ² : E13*55R00*55R01*3509*00
Type-approval number ² :

Motif de l'extension : Not applicable
Reason of extension :

SECTION I SECTION I

- 0.1. **Marque (raison sociale du constructeur) :** URBENI
Make (trade name of manufacturer) :
- 0.2. **Type :** P 030
Type :
- Description(s) commerciale(s) générale(s) :** Detachable coupling ball
General commercial description(s) :
- Version(s)/Variante(s) :** -A
Version(s)/Variant(s) : -B

CERTIFICADO DE MONTAJE

D., expresamente autorizado por la empresa....., domiciliada en provincia de, calle nº teléfono, dedicada a la actividad, con nº de Registro Industrial y nº de registro especial (1).....

CERTIFICA

Que la mencionada empresa ha realizado la/s reforma/s, y asume la responsabilidad de la ejecución, sobre el vehículo marca tipo variante denominación comercial matrícula y nº de bastidor de acuerdo con:

- La normativa vigente en materia de reformas de vehículos.
- Las normas del fabricante del vehículo aplicables a la/s reforma/s llevadas a cabo en dicho vehículo.
- El proyecto técnico de la/s reforma/s, adjunto al expediente.

OBSERVACIONES:

INSTALACIÓN DE DISPOSITIVO PARA REMOLCAR,

MARCA:

Nº HOMOLOGACIÓN: e.....*94/20*

VALOR D:kN

VALOR S:Kg

M.M.R.:Kg

Se garantiza que los equipos o sistemas modificados cumplen lo previsto en el artículo 6 del Reglamento General de vehículos y, en su caso, en el artículo 9 del Real Decreto 147/1986, de 10 de enero, por el que se regula la actividad industrial en talleres de vehículos automóviles, de equipos y sus componentes, modificados por 455/2010, de 16 de abril, por el que se modifica el Real Decreto 1457/1986, de 10 de enero, por el que se regulan la actividad industrial y la prestación de servicios en los talleres de reparación de vehículos automóviles, de sus equipos y componentes.

..... a de de 20.....

Firma y Sello

Fdo.:

(1) En el caso de que la reforma sea efectuada por un fabricante se indicará N/A



INVALID

DA COMPILARE PER IL COLLAUDO

DICHIARAZIONE DI CORETTO MONTAGGIO

La sottoscritta Ditta dichiara di aver montato in maniera corretta ed in conformità alle prescrizioni sia del costruttore del veicolo che del costruttore del dispositivo stesso il seguente dispositivo di attacco meccanico:

Tipo:

Il dispositivo di attacco meccanico sopra descritto è stato installato su autoveicolo tipo:

.....

targa:

.....

Si dichiara inoltre di aver informato l'utente del veicolo sull'USO e MANUTENZIONE del dispositivo stesso.

TIMBRO E FIRMA

.....



Dispositivo di traino

codice:

Per autoveicoli:

Tipo:

Clase e tipo di attacco:

Omologazione:

Valor D:

Massa Massima

Rimorchiabile:

Carico Verticale Massimo:

Larghezza max.

Rimorquiabile

per Caravan e T.A.T.S.: Vedere CARTA di
CIRCOLAZIONE VEICOLO

(motrice) + 70 cm =.....
arrotondare ai 5 cm superiore

(vedi D.M. 28/05/85)



