

RENAULT LAGUNA II ('01-)

-
- ✧ **Enganche fabricado por URBENI adaptable a la marca del vehículo.**
 - ✧ **Towbar made by URBENI adaptable to the brand of the vehicle.**
 - ✧ **Attelage fabriqué par URBENI adaptable à la marque de ce véhicule.**
 - ✧ **Für dieses Fahrzeug angepasst und hergestellt durch URBENI**
 - ✧ **Dispositivo de traino URBENI adeguato alla marca di questo veicolo.**

URBENI le ofrece una garantía del producto por un periodo de 2 años desde la fecha de entrega. conforme lo dispuesto en la directiva 1999/44/CE y la ley 23/2003, esta garantía está limitada a reemplazar el producto defectuoso y en ningún caso se extenderá a daños o perjuicios consecuenciales.

THE URBENI's products have a warranty period of 2 years after the delivery date, conform to the standard 1999/44/CE, this warranty is limited to the replacement of the defective products, and it will not never cover any derivate damages.

Les produits d'URBENI ont une garantie de 2 ans depuis la date de livraison ce qui est conforme à la Normative Européenne 1999/44CE. Cette garantie inclue de remplacer le produit défectueux, mais en aucun cas les dommages ou préjudices conséquents

URBENI gewährt eine Garantie von einen 2 Jahre in ordnung nach dem Fertigungsnorm. Der Hersteller behält sich das Recht vor die schadhafte Ware zu repaieren oder zu ersetzen und in keinem Fall übernimmt er Folgekosten für Schäden an Dritten.

Bemerkung: Für einen Mangel am Produkt, der durch den Fahrzeughalter oder eine andere. Person aufgrund unsachgemäßer Benutzung verursacht wurde, übernimmt Urbeni keine Haftung. Alle befestigungsschrauben der KmH nach ca. 1000 Anhänger-Km und bei jeder Fahrzeuginspektion gemäss den angegebenen Anziehdrehmomenten nachziehen

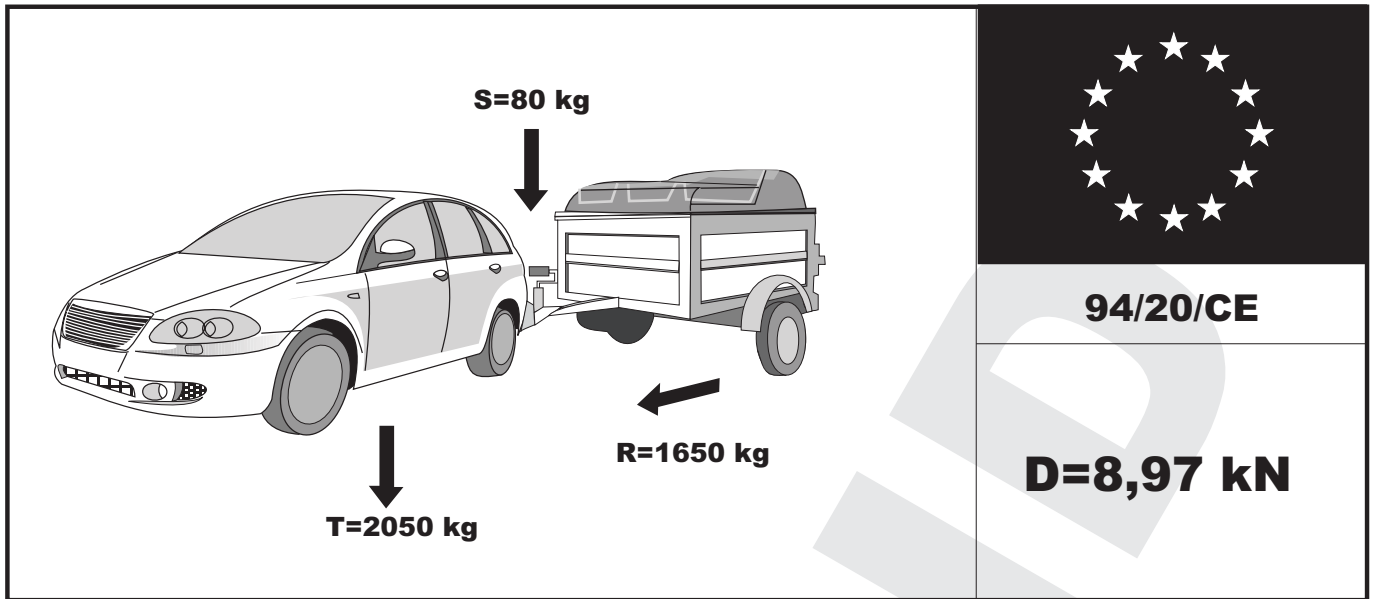

$g = 9,81 \text{ m/s}^2$

$$D = \frac{T \cdot R}{1000 \cdot (T + R)} \cdot g \quad T = \frac{R \cdot D \cdot 1000}{(g \cdot R) - (1000 \cdot D)} \quad R = \frac{R \cdot D \cdot 1000}{(g \cdot T) - (1000 \cdot D)}$$

kN
kg
kg

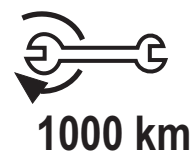
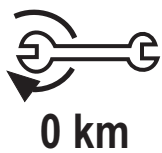

	M8	M10	M12	M14	M16
N · m	23	50	80	135	200

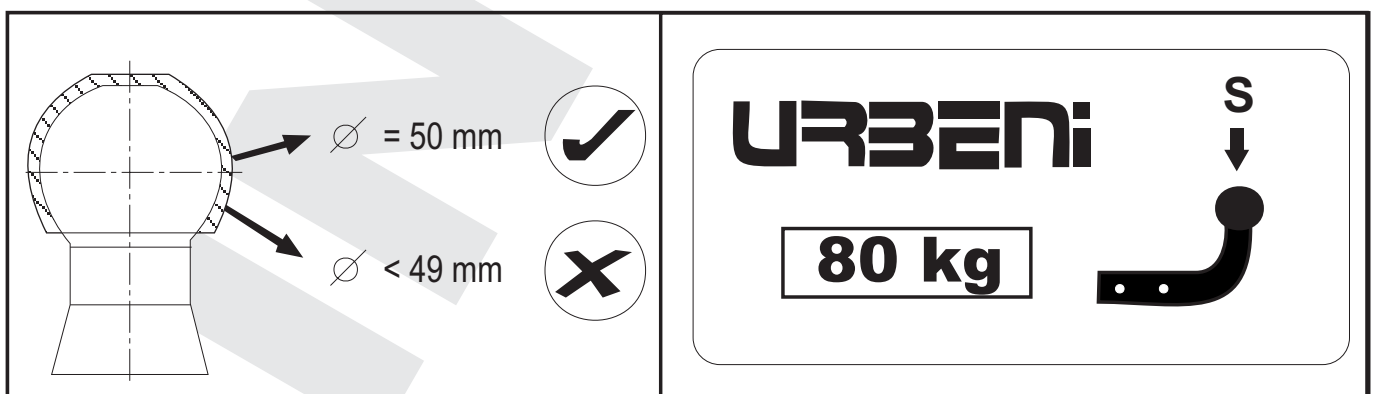

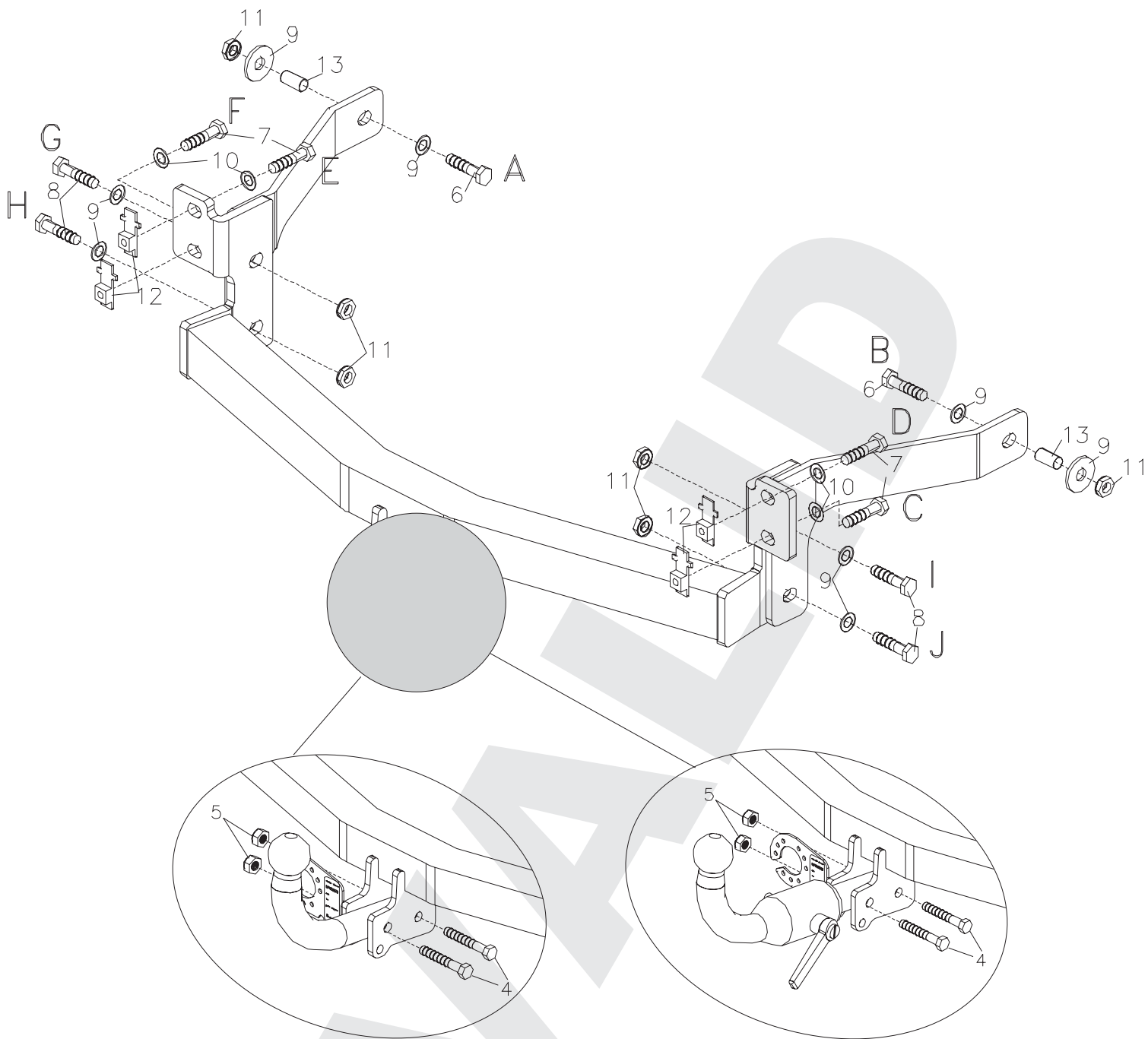











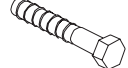

REF: 02964

URBENi
 CLASS **A50-X**
 APPROVAL NUMBER
e13 00*0900
 TYPE **R 017 F**
 D-VALUE
 D **8,97** kN
 MAX.VERT.LOAD.
 S **80** kg
 www.urbeni.com
 MADE IN SPAIN

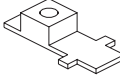
REF: 22964

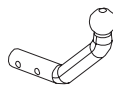
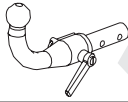
URBENi
 CLASS **A50-X**
 APPROVAL NUMBER
e13 00*0900
 TYPE **R 017 FD**
 D-VALUE
 D **8,97** kN
 MAX.VERT.LOAD.
 S **80** kg
 www.urbeni.com
 MADE IN SPAIN

N°		Q	
1		1	
2		1	
3		1	
6		2	M10x100 DIN 931
7		4	M8x30 DIN 933
8		4	M10x40 DIN 933
9		8	M10 DIN 9021
10		4	M8 DIN 125
11		6	M10 DIN 6923
12		4	
13		2	DIAM 16x59mm.
			
			
4		2	M12x70 DIN 931
5		2	M12 DIN 985

1

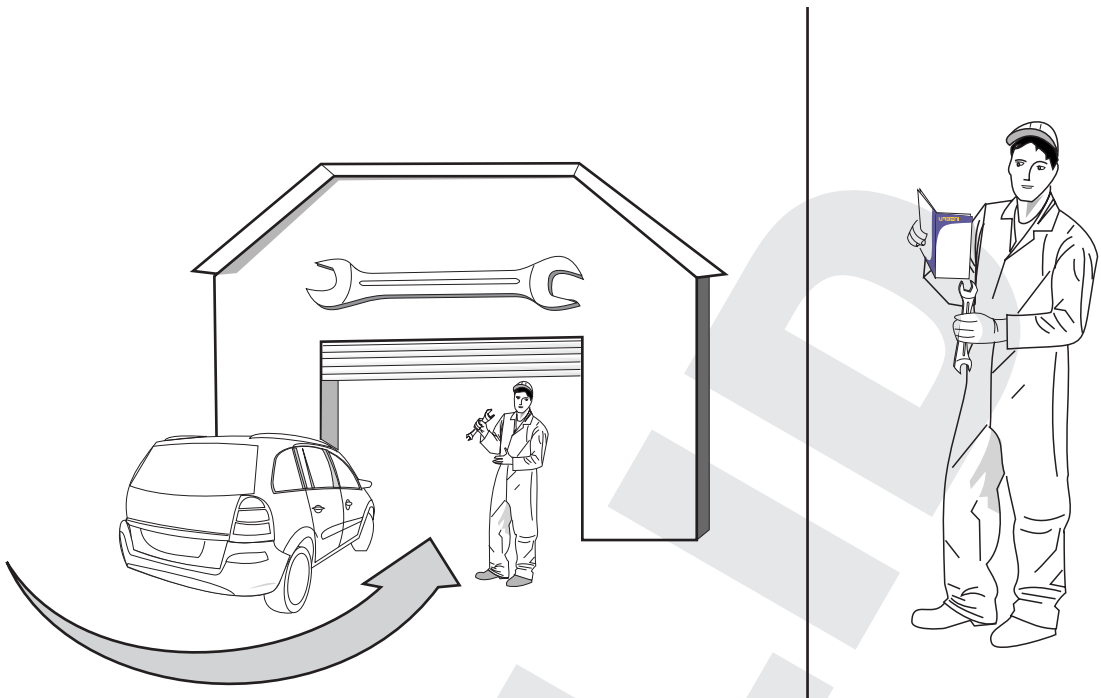

2

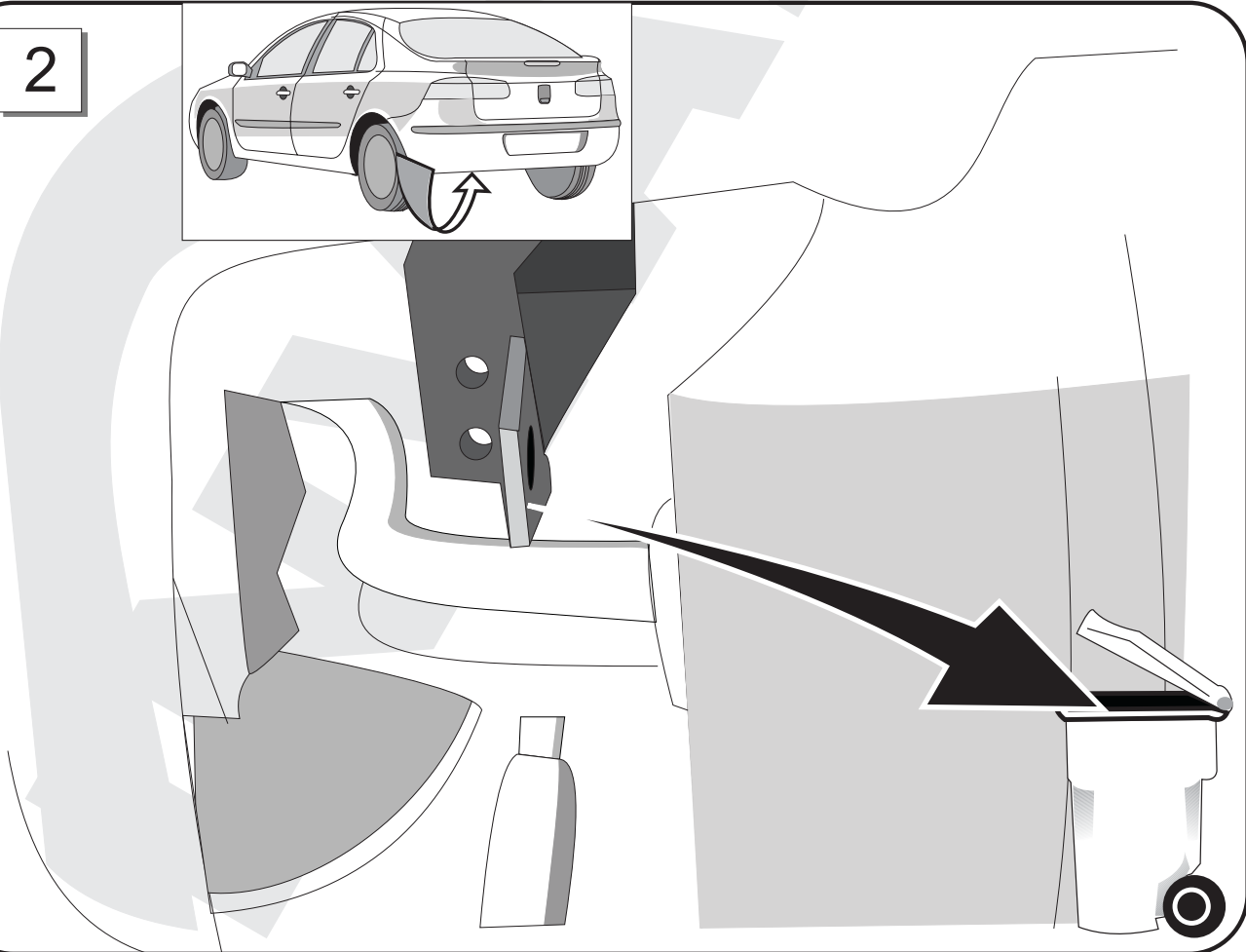
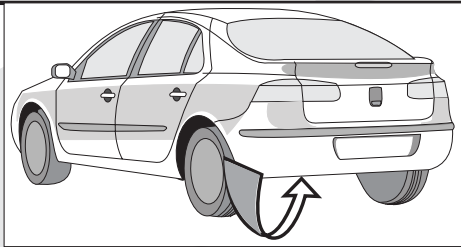

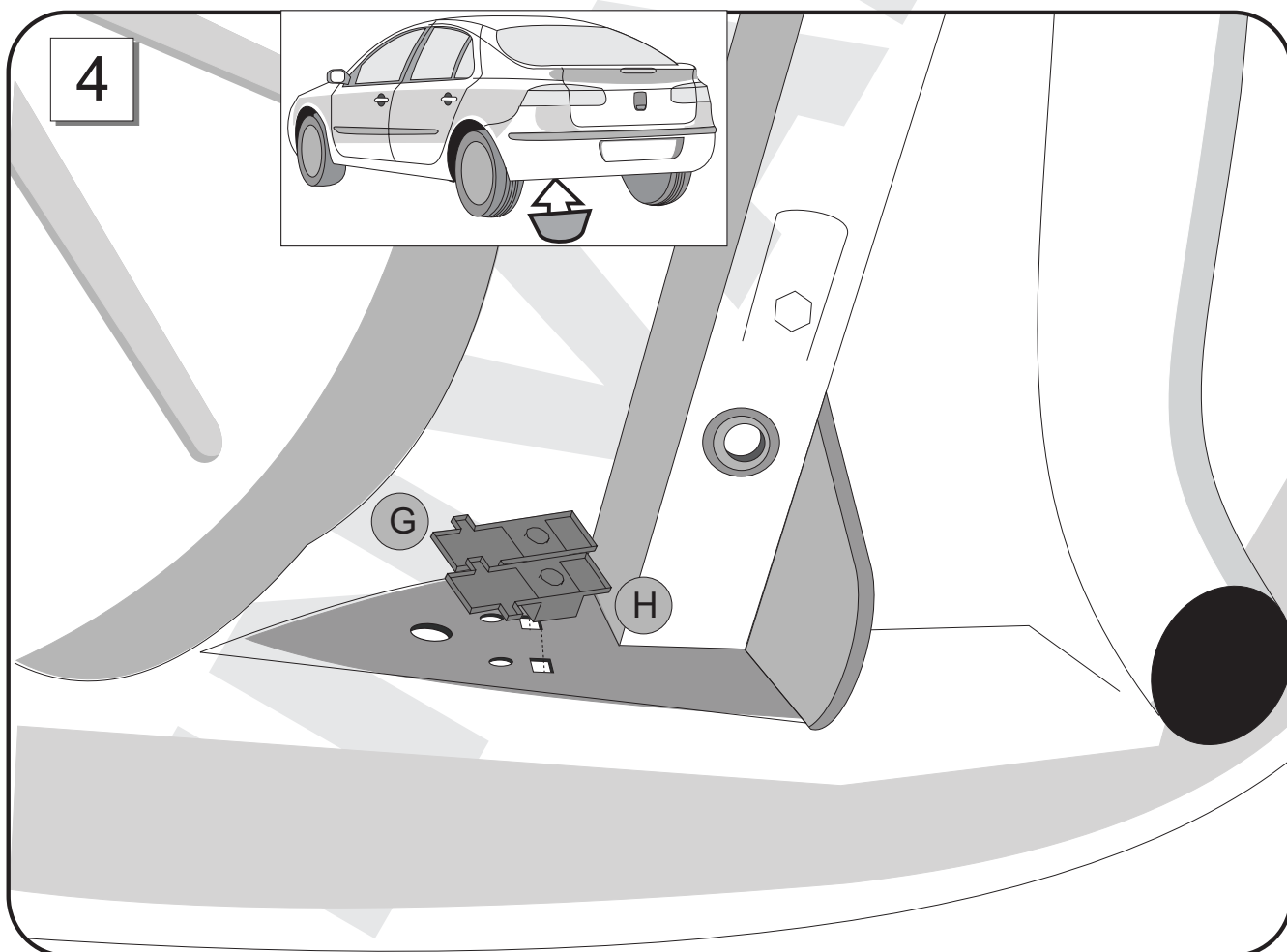
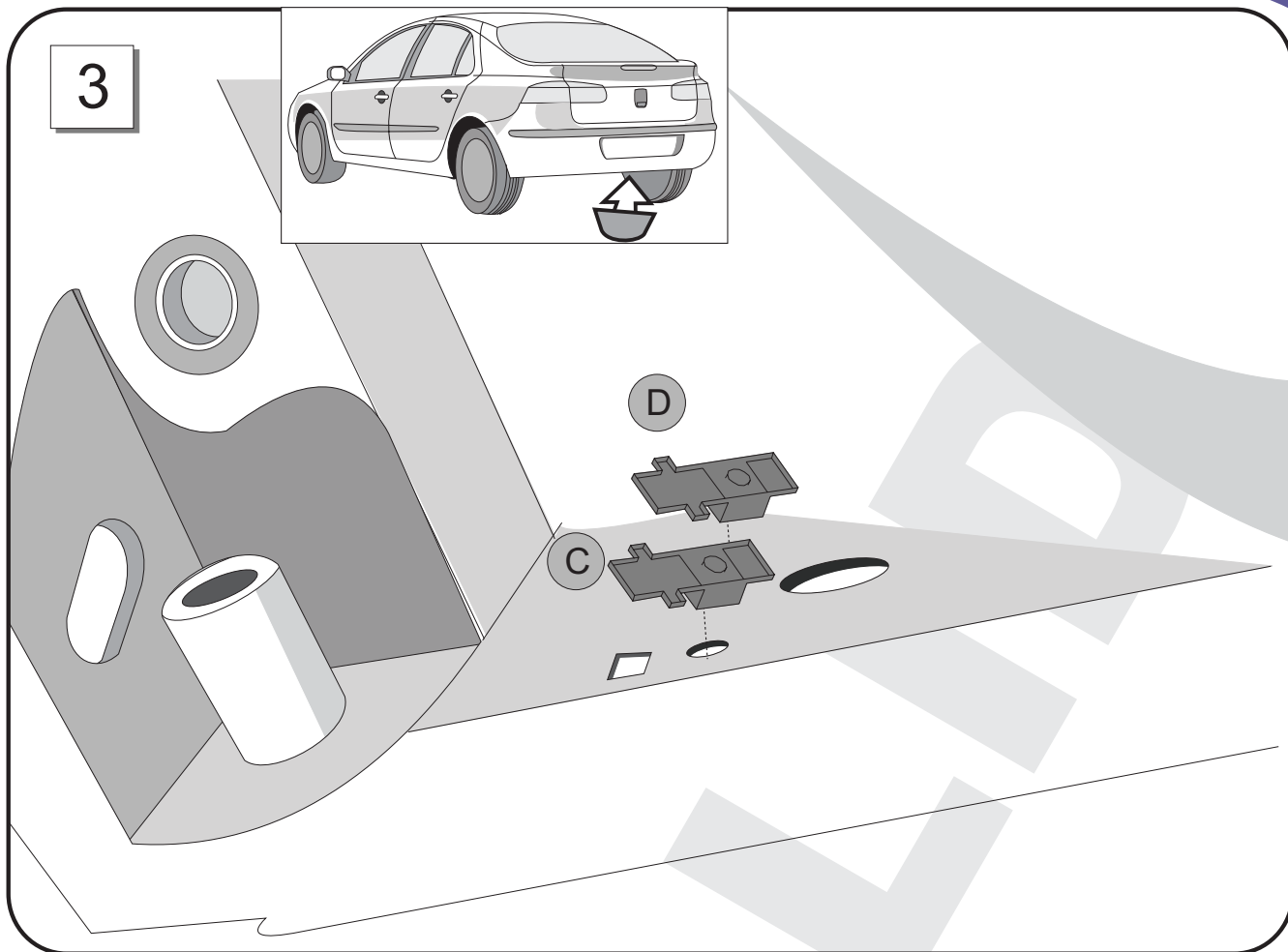

5

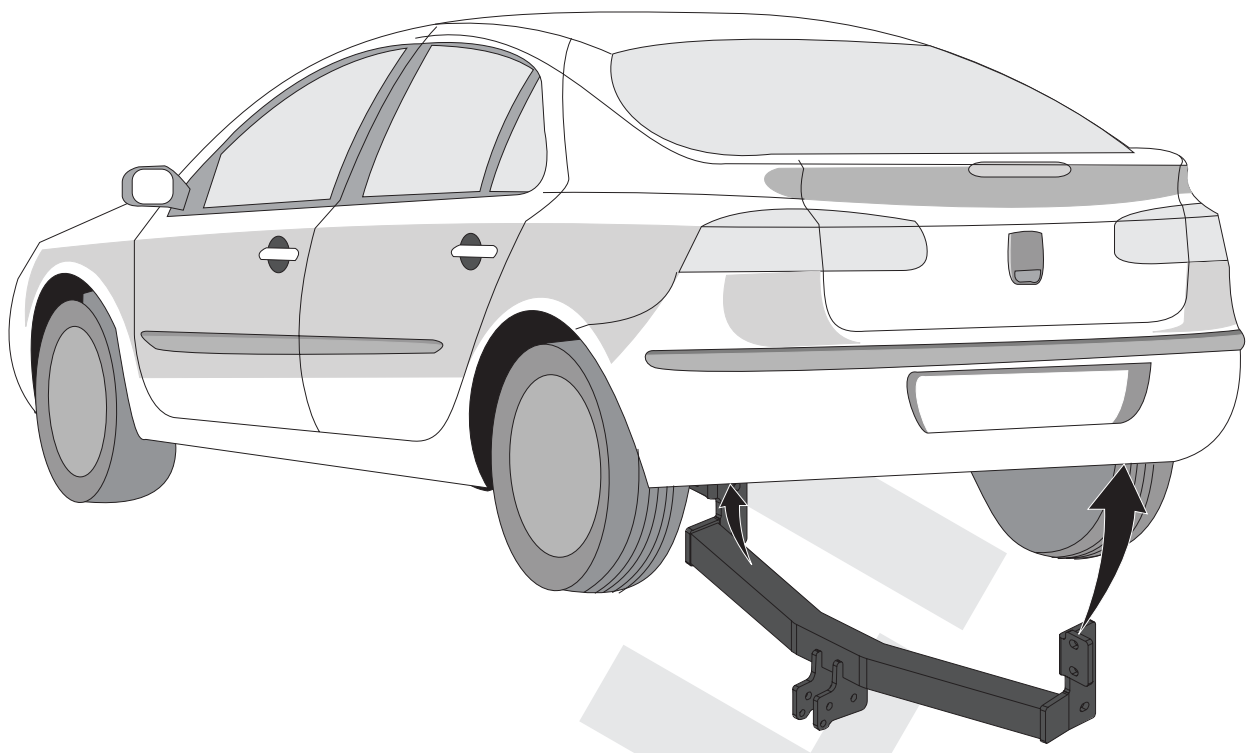

6

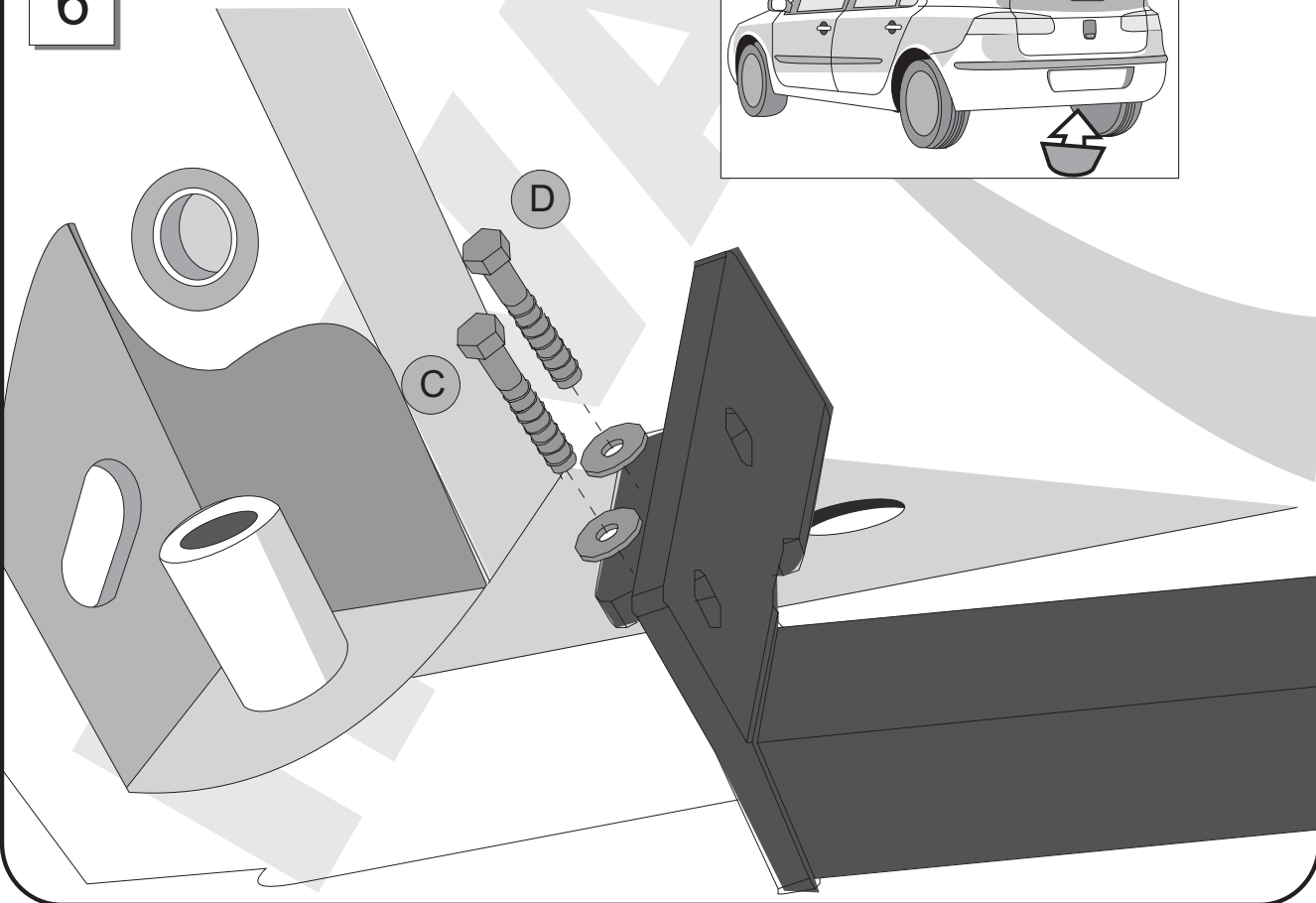
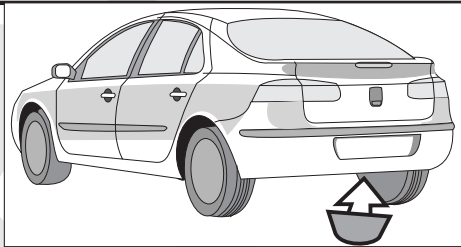

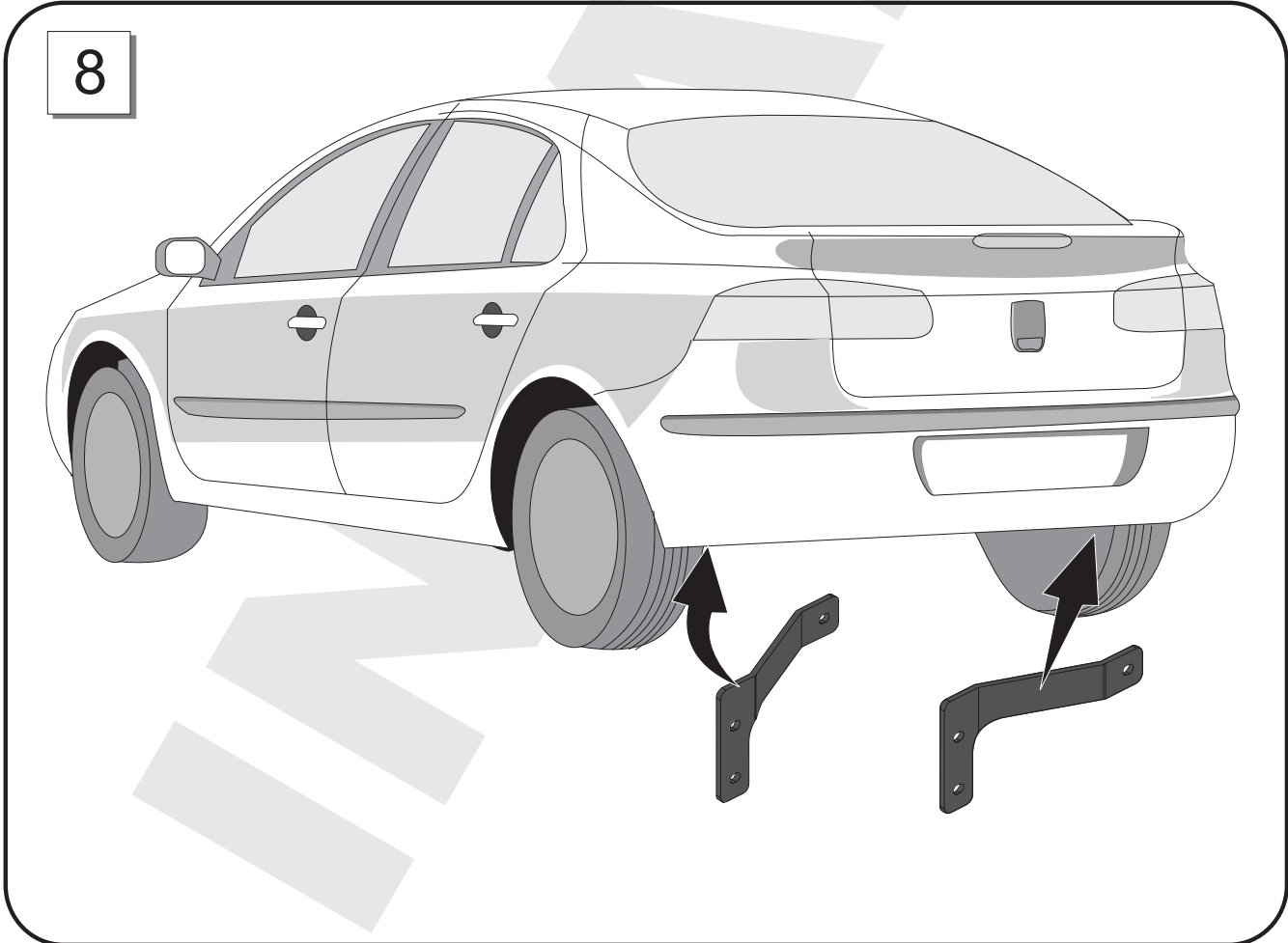
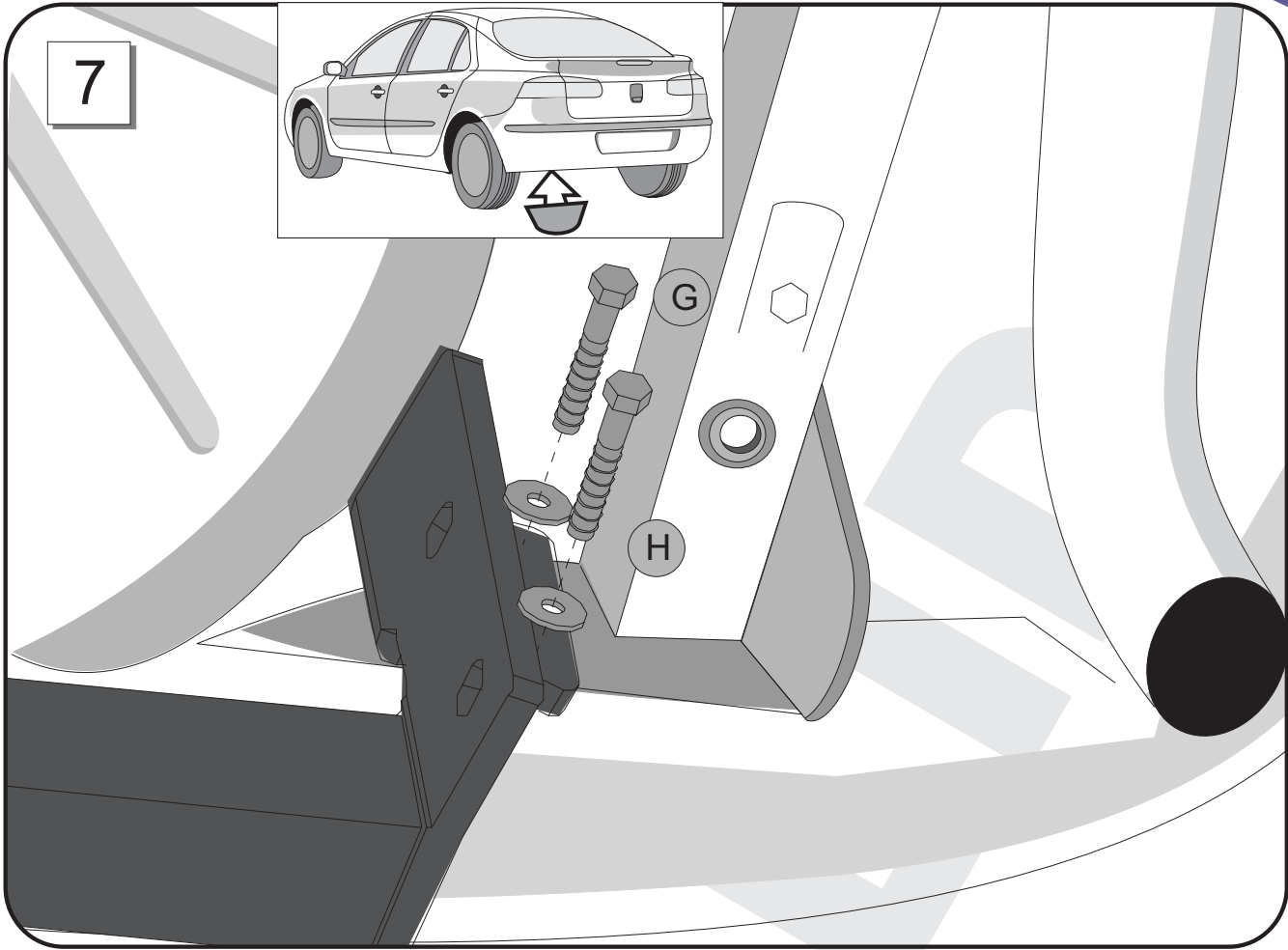

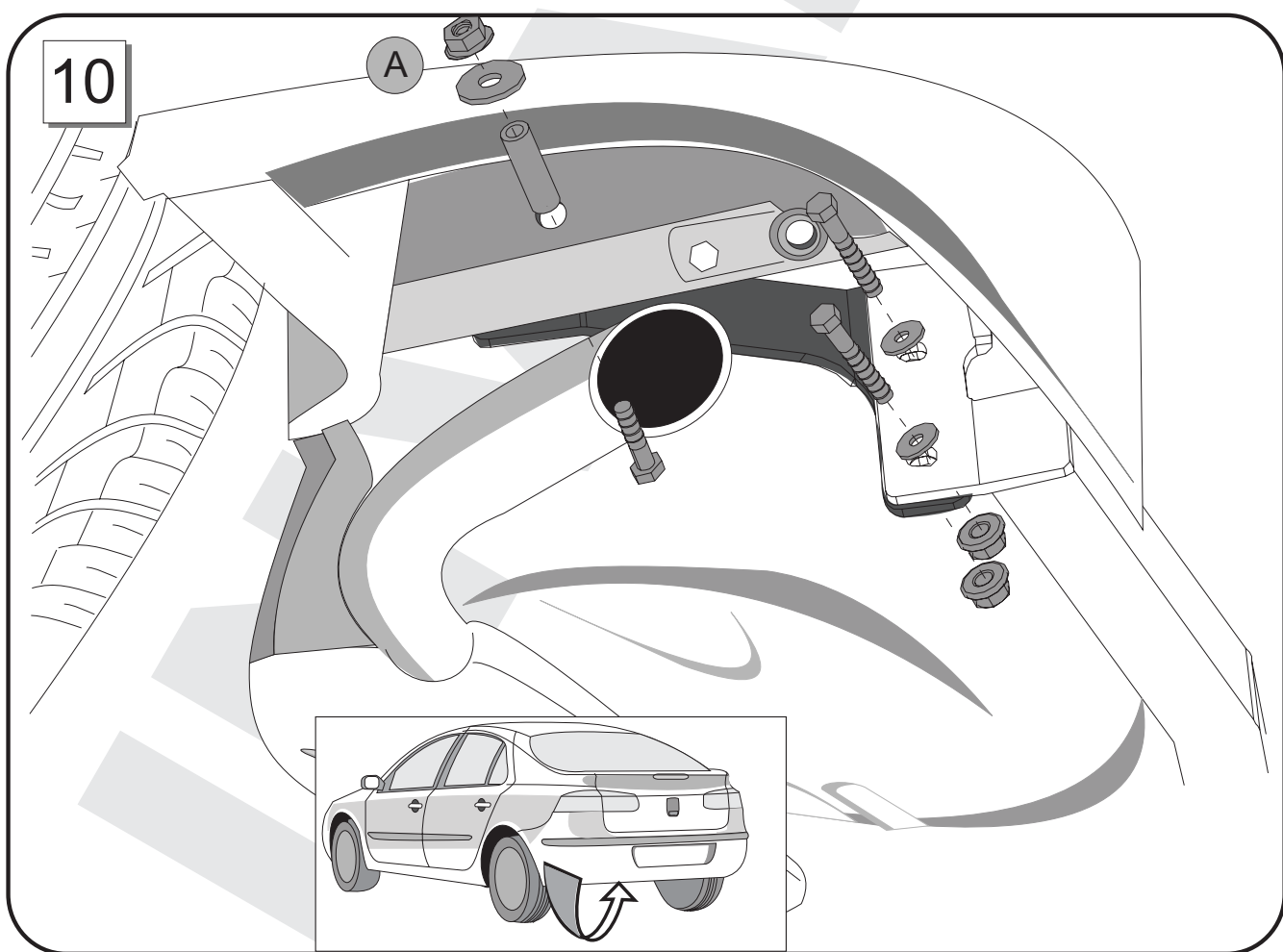
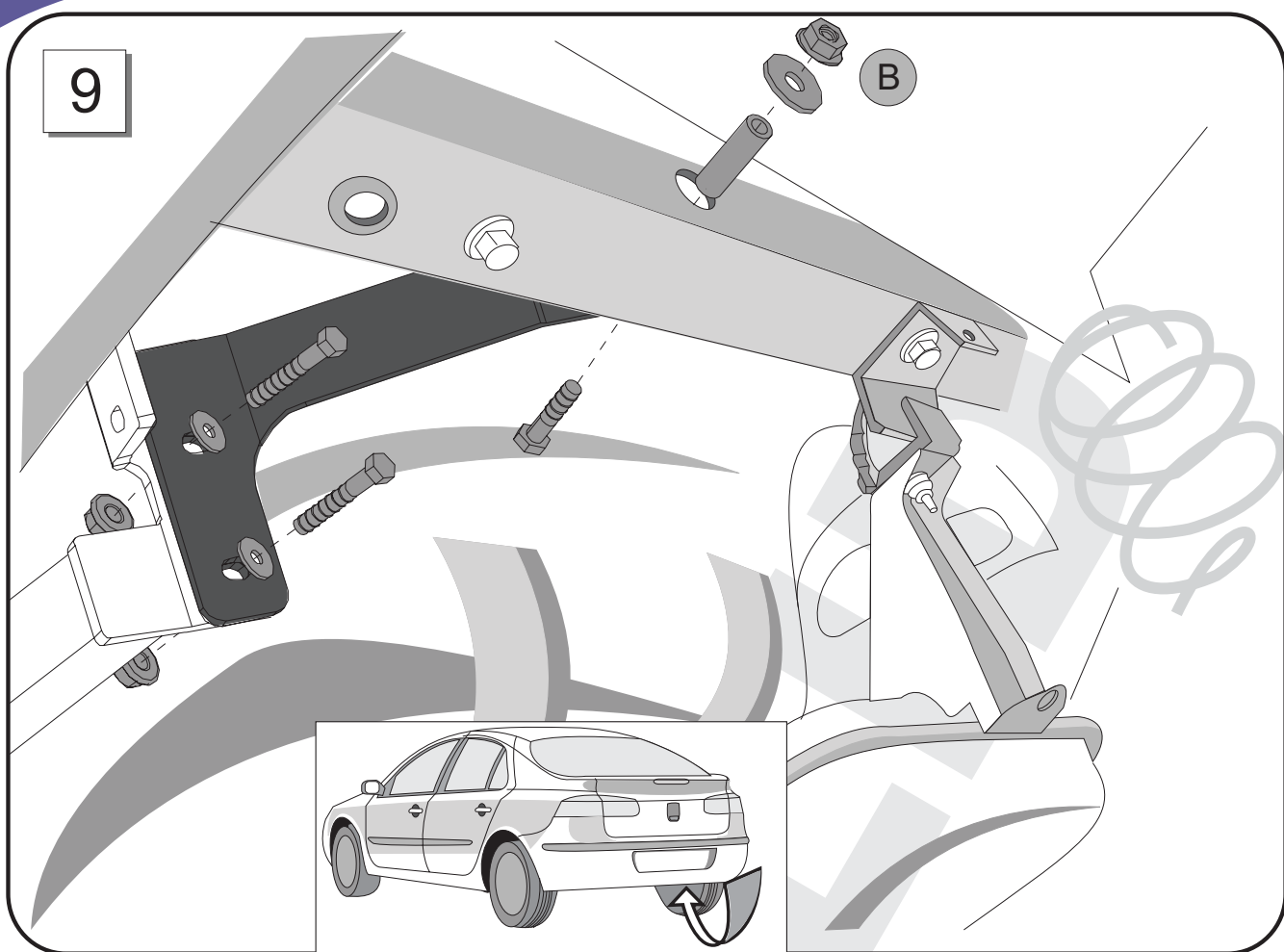

11

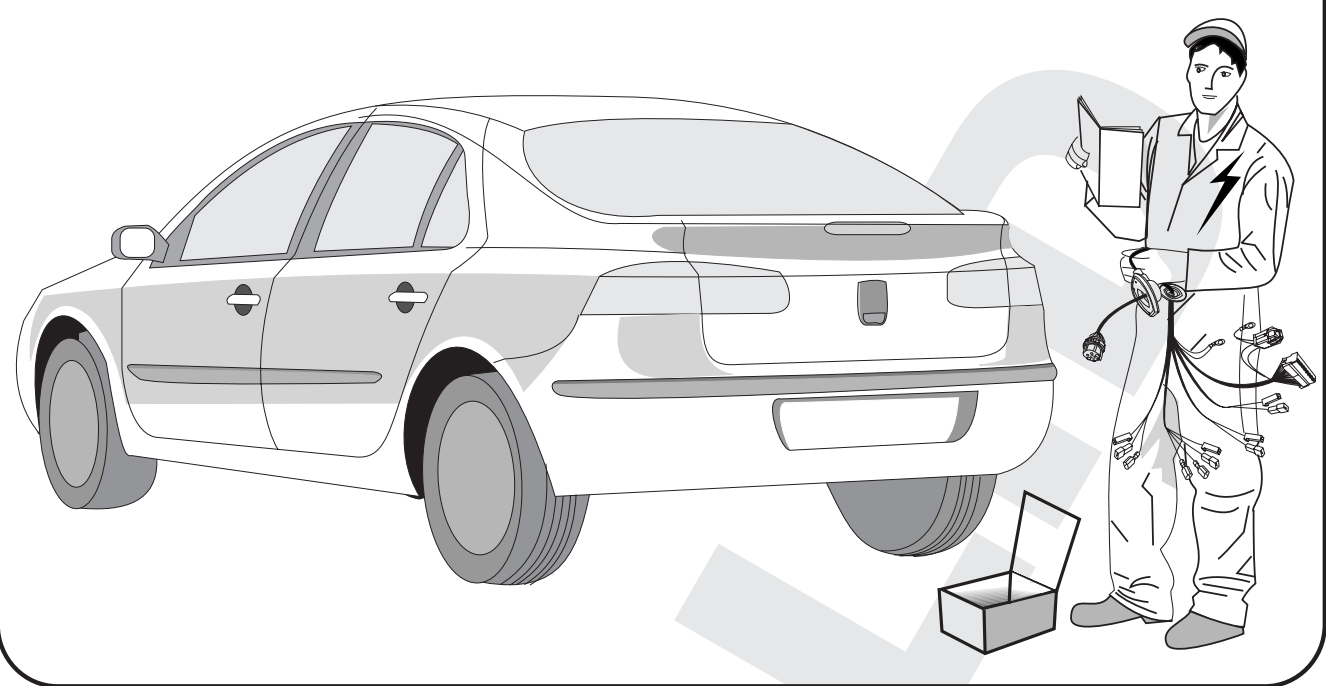

12

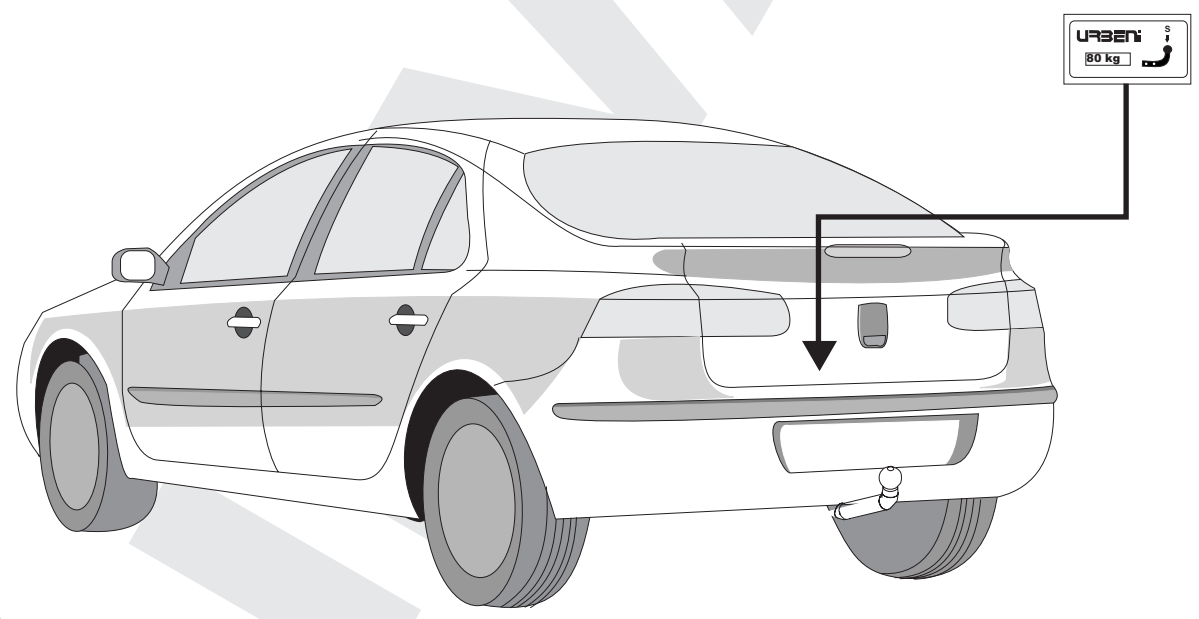

13

E I



NL GR IRL DK
GB F D CZ

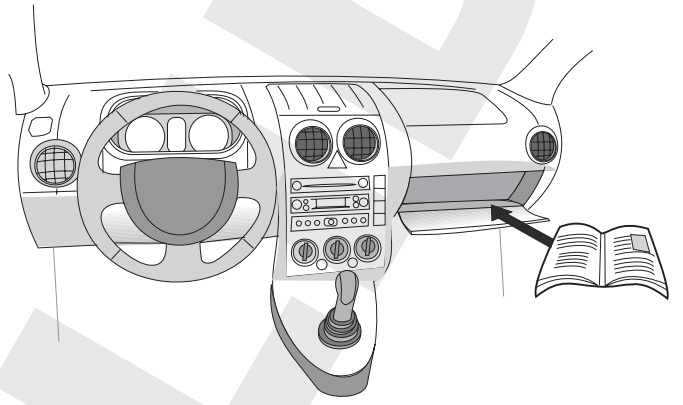
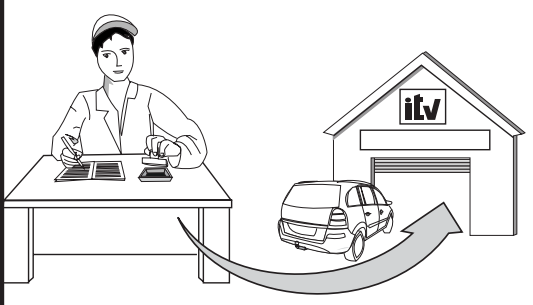

INVA

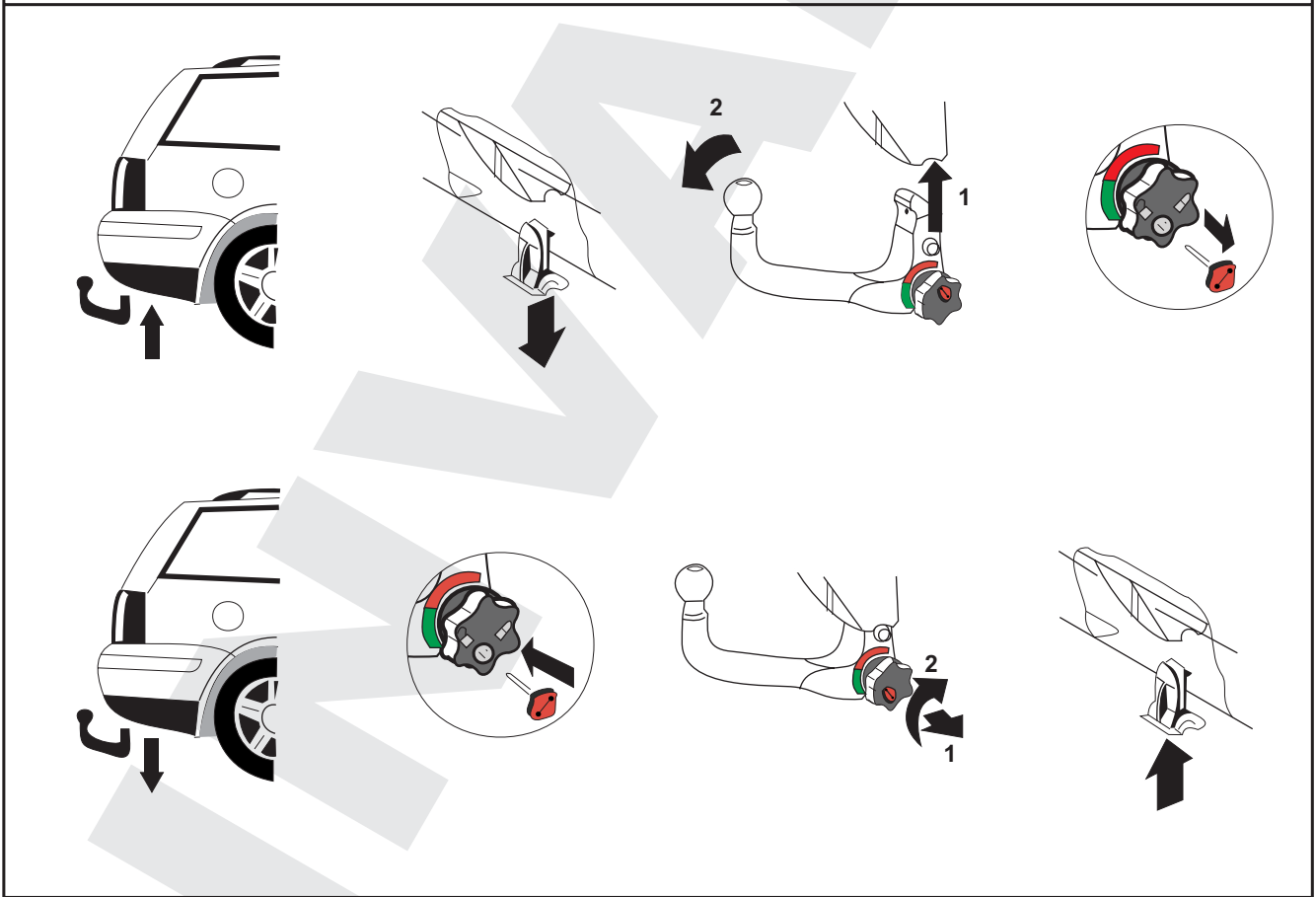
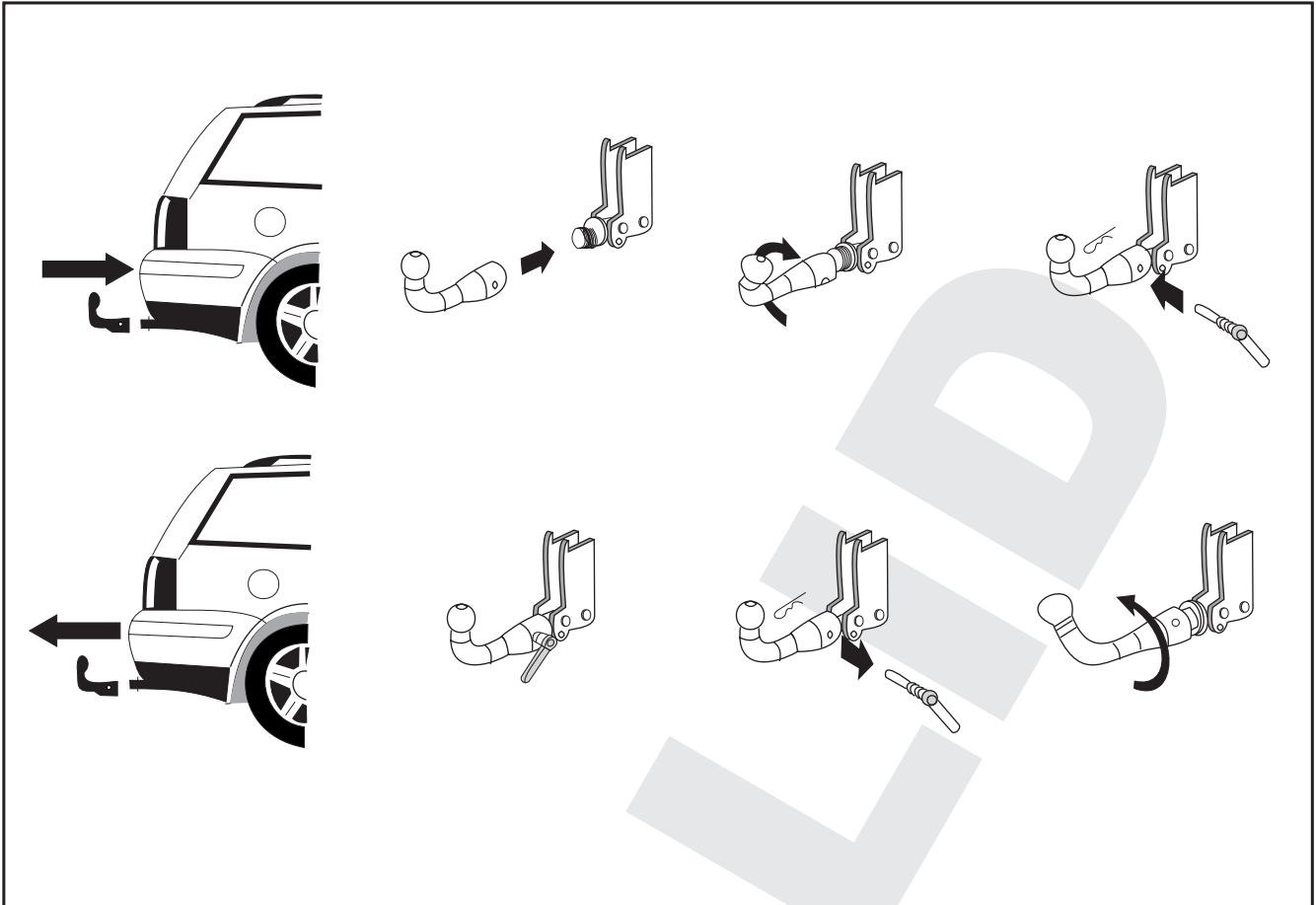

MINISTERE DES TRANSPORTS

Luxemburg, le 01 mars 2001
19-21, Boulevard Royal
L-2910 LUXEMBOURG
Tél- 478-1 Télécopieur 241817 - Télex 1465 CIVAIR LU

REFERENCE : No e13*94/20*94/20*0900*00

ANNEXES : Documentation technique

FICHE DE RECEPTION CEE
EC TYPE-APPROVAL CERTIFICATE



Communication concernant
Communication concerning

- la réception
the type approval
- ~~l'extension de la réception~~
~~the extension of type approval~~
- ~~le refus de la réception~~
~~the refusal of type approval~~
- ~~le retrait de la réception~~
~~the withdrawal of type approval~~

d'un type d'élément de construction visé par la directive 94/20/CE⁽¹⁾
of a type of a component with regard to Directive 94/20/EC⁽¹⁾

Numéro de réception⁽²⁾ : e13*94/20*94/20*0900*00
Type-approval number⁽²⁾ :

Motif de l'extension : not applicable
Reason of extension :

SECTION I
SECTION I

- 0.1. Marque (raison sociale du constructeur) :** URBENI
Make (trade name of manufacturer) :
- 0.2. Type et descripton(s) commerciale(s) générale(s) :** R 017
Type and general commercial description(s) :
- 0.3. Moyens d'identification du type, tels que marqués sur l'élément de construction⁽³⁾ :** see point 0.7.
Means of identification of type if marked on the component⁽³⁾ :

URBENI, S.L.

Pol.Centrovia, A-2, Km 303. c/Buenos Aires, n°10
50196 LA MUELA-ZARAGOZA (ESPAÑA)
Tel.: +34 976 14 44 01 / +34 902 41 78 50
Fax.: +34 976 14 44 02

DA COMPILARE PER IL COLLAUDO

DICHIARAZIONE DI CORETTO MONTAGGIO

La sottoscritta Ditta dichiara di aver montato in maniera corretta ed in conformità alle prescrizioni sia del costruttore del veicolo che del costruttore del dispositivo stesso il seguente dispositivo di attacco meccanico:

Tipo:

Il dispositivo di attacco meccanico sopra descritto è stato installato su autoveicolo tipo:

.....

targa:

.....

Si dichiara inoltre di aver informato l'utente del veicolo sull'USO e MANUTENZIONE del dispositivo stesso.

TIMBRO E FIRMA

.....

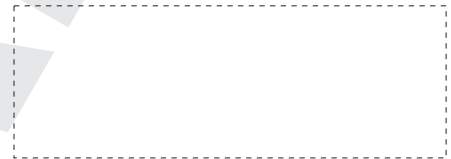

Dispositivo di traino

codice:

Per autoveicoli:

Tipo:

Clase e tipo di attacco:

Omologazione:

Valor D:

Massa Massima

Rimorchiabile:

Carico Verticale Massimo:

Larghezza max.

Rimorquiabile

per Caravan e T.A.T.S.: Vedere CARTA di
CIRCOLAZIONE VEICOLO

(motrice) + 70 cm =.....
arrotondare ai 5 cm superiore

(vedi D.M. 28/05/85)



CERTIFICADO DE MONTAJE

D./Dña., responsable técnico de la empresa....., domiciliada en provincia de, calle nº teléfono, dedicada a la actividad, con nº de Registro Industrial

CERTIFICA

Que la mencionada empresa ha realizado la/s reforma/s consistente/s en: ⁽¹⁾

Incorporación de dispositivo para remolcar, marca:
Con nº de identificaciónmarca de homologación:

Tipificada/s en el Real Decreto 736/1988 con el/los número/s (2) sobre el vehículo marca, tipo, variante denominación comercial, matrícula y nº de bastidor, de acuerdo con:

- La normativa vigente en materia de reformas de importancia de vehículos.
- Las condiciones del informe favorable, o en su caso, las normas del fabricante del vehículo aplicables a la/s reforma/s llevadas a cabo en él.
- El proyecto descriptivo de la/s reforma/s, adjunto al expediente.

OBSERVACIONES:

La reforma efectuada no necesita proyecto según Régimen Transitorio tipificado en el párrafo primero, de la disposición 3ª de la página 44.034 del B.O.E. nº 301 de fecha de publicación 17 de diciembre de 2002

_____ a _____ de _____ de _____

Firma y Sello

Fdo, el responsable técnico.: _____

⁽¹⁾ Se describirán las operaciones básicas realizadas sobre el vehículo y se citarán los elementos y sistemas instalados.

⁽²⁾ Si el dispositivo para remolcar no cumple con la normativa 94/20/CE poner "26"
Si el dispositivo para remolcar cumple con la normativa 94/20/CE dejar en blanco y proceder a la anotación en la tarjeta ITV adjuntando el certificado de montaje del taller y el manual de instrucciones de montaje.



INVALID

INVALID