

MERCEDES CLASE C BERLINA W-203 ('00-)
MERCEDES CLASE C BREAK S-203 ('01-)

-
- ✧ **Enganche fabricado por URBENI adaptable a la marca del vehículo.**
 - ✧ **Towbar made by URBENI adaptable to the brand of the vehicle.**
 - ✧ **Attelage fabriqué par URBENI adaptable à la marque de ce véhicule.**
 - ✧ **Für dieses Fahrzeug angepasst und hergestellt durch URBENI**
 - ✧ **Dispositivo de traino URBENI adeguato alla marca di questo veicolo.**

URBENI le ofrece una garantía del producto por un periodo de 2 años desde la fecha de entrega, conforme lo dispuesto en la directiva 1999/44/CE y la ley 23/2003, esta garantía está limitada a reemplazar el producto defectuoso y en ningún caso se extenderá a daños o perjuicios consecuenciales.

THE URBENI's products have a warranty period of 2 years after the delivery date, conform to the standard 1999/44/CE, this warranty is limited to the replacement of the defective products, and it will not never cover any derivate damages.

Les produits d'URBENI ont une garantie de 2 ans depuis la date de livraison ce qui est conforme à la Normative Européenne 1999/44CE. Cette garantie inclue de remplacer le produit défectueux, mais en aucun cas les dommages ou préjudices conséquents

URBENI gewährt eine Garantie von einen 2 Jahre in ordnung nach dem Fertigungsnorm. Der Hersteller behält sich das Recht vor die schadhafte Ware zu repaieren oder zu ersetzen und in keinem Fall übernimmt er Folgekosten für Schäden an Dritten.

Bemerkung: Für einen Mangel am Produkt, der durch den Fahrzeughalter oder eine andere. Person aufgrund unsachgemäßer Benutzung verursacht wurde, übernimmt Urbeni keine Haftung. Alle befestigungsschrauben der KmH nach ca. 1000 Anhänger-Km und bei jeder Fahrzeuginspektion gemäss den angegebenen Anziehdrehmomenten nachziehen

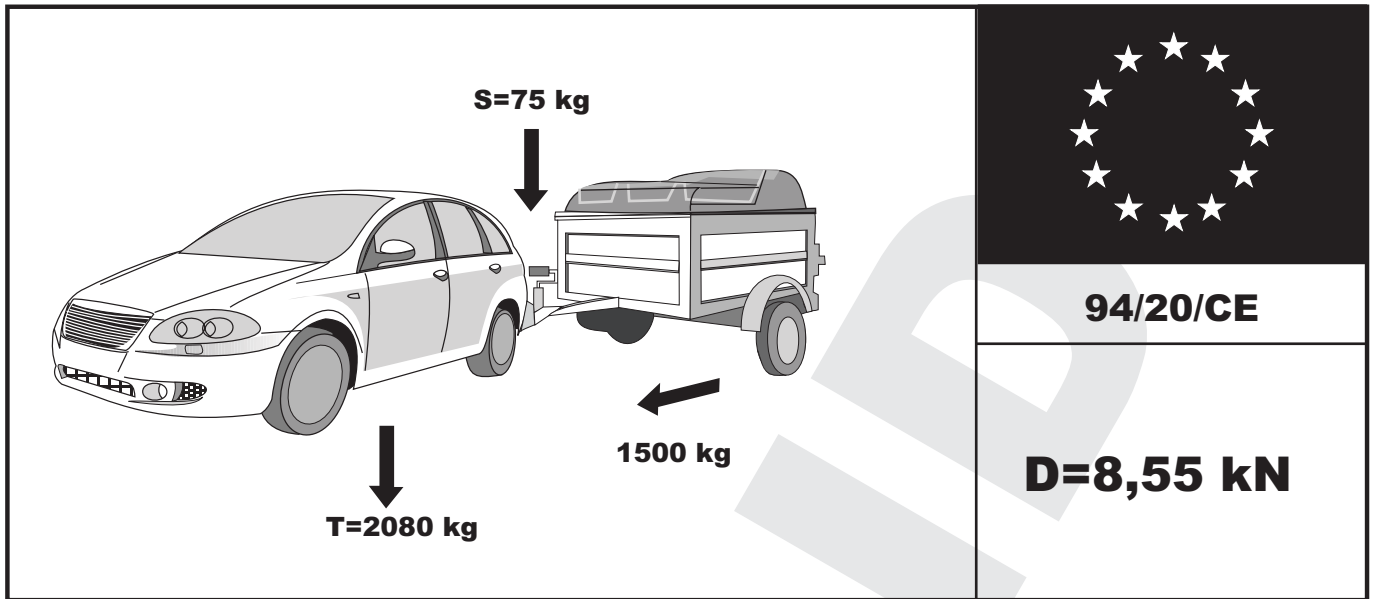

$g = 9,81 \text{ m/s}^2$

$$D = \frac{T \cdot R}{1000 \cdot (T + R)} \cdot g \quad T = \frac{R \cdot D \cdot 1000}{(g \cdot R) - (1000 \cdot D)} \quad R = \frac{R \cdot D \cdot 1000}{(g \cdot T) - (1000 \cdot D)}$$

kN
kg
kg

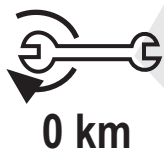

	M8	M10	M12	M14	M16
N · m	23	50	80	135	200

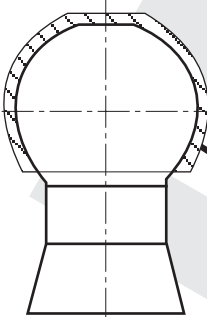

Ø = 50 mm

Ø < 49 mm



75 kg

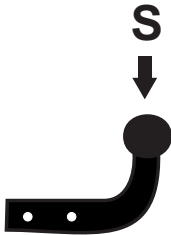

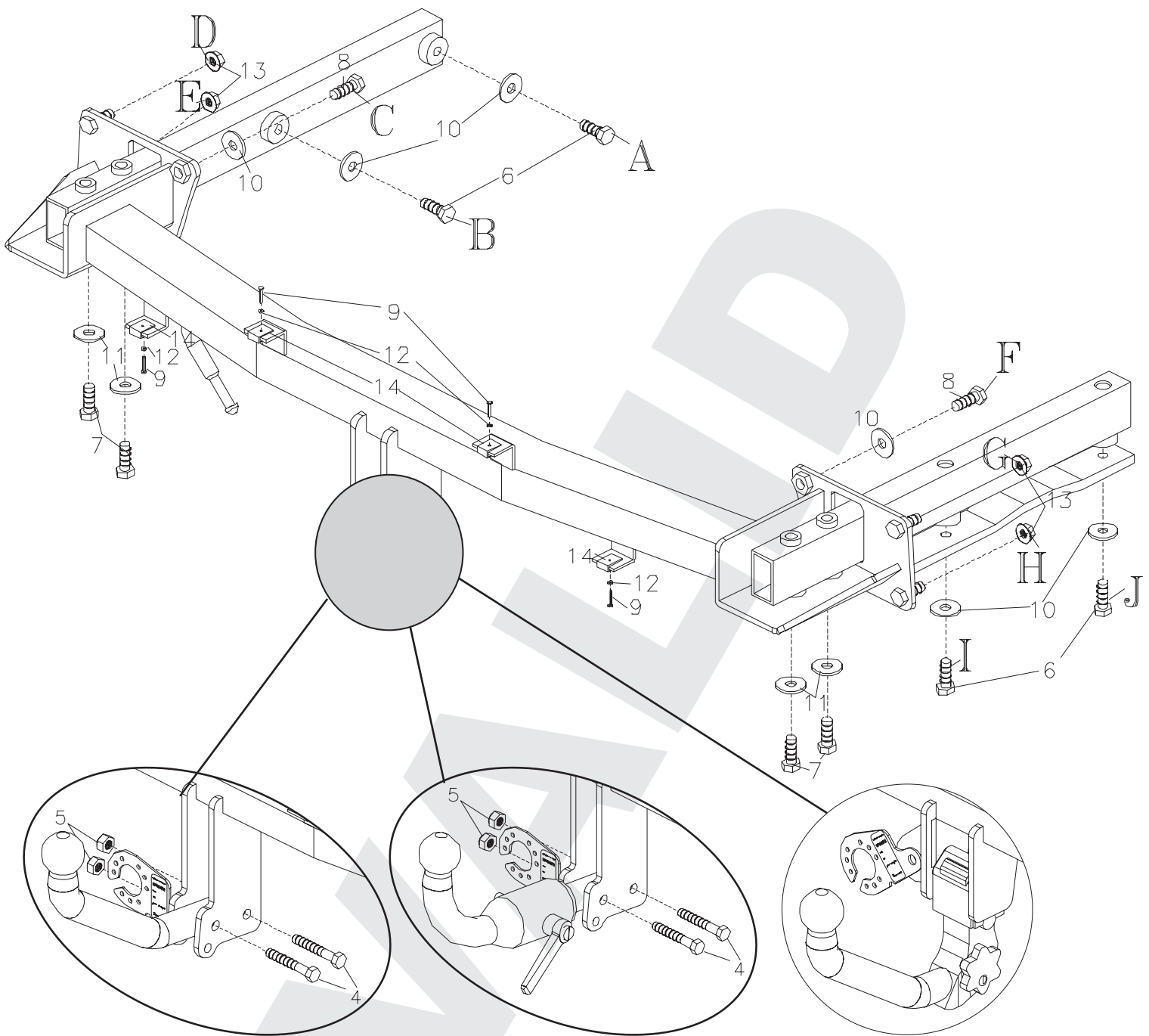

REF: 02125

URBENI

CLASS **A50-X**

APPROVAL NUMBER
e13 00*1550

TYPE **M 007**

D-VALUE
D **8,55** kN

MAX.VERT.LOAD.
S **75** kg

www.urbeni.com
MADE IN SPAIN

REF: 22125

URBENI

CLASS **A50-X**

APPROVAL NUMBER
e13 00*1551

TYPE **M 008 A**

D-VALUE
D **8,55** kN

MAX.VERT.LOAD.
S **75** kg

www.urbeni.com
MADE IN SPAIN

REF: 82125

URBENI

CLASS **A50-X**







APPROVAL NUMBER
e13 00*1551

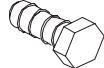

TYPE **M 008 B**

D-VALUE
D **8,55** kN

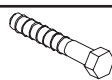
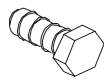
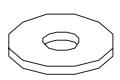
MAX.VERT.LOAD.
S **75** kg

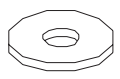
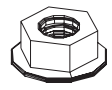
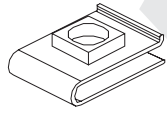
www.urbeni.com
MADE IN SPAIN

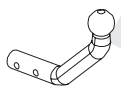
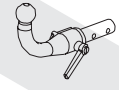
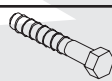
N°		Q	
1		1	
2		1	
3		1	
6		4	M10x30 DIN 933
7		4	M12x40 DIN 933
8		2	M10x60 DIN 931
9		4	M5x15 DIN 933
10		6	M10 DIN 9021
11		4	M12 DIN 9021
12		4	M6 DIN 9021
13		4	M10 DIN 6923
14		4	

			
4		2	M12x70 DIN 931
5		2	M12 DIN 985

1

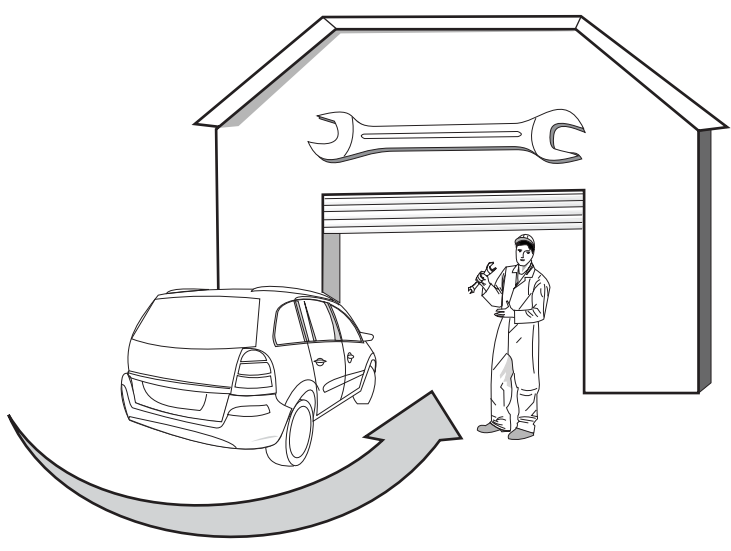

2

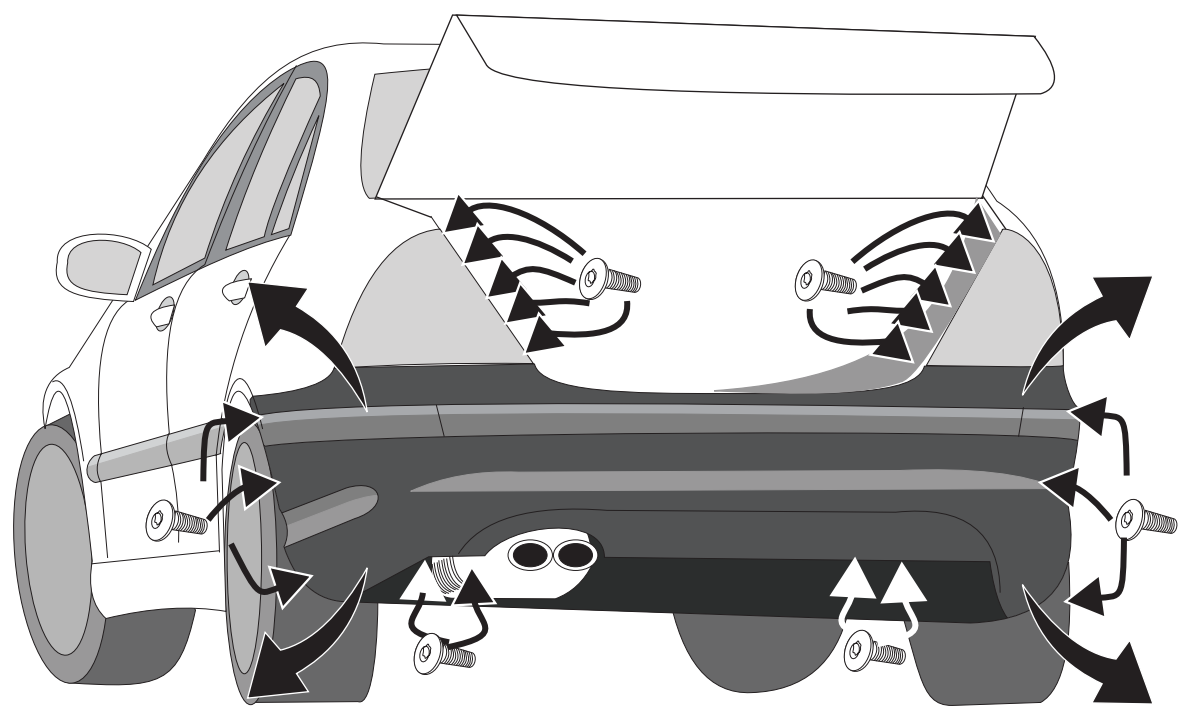

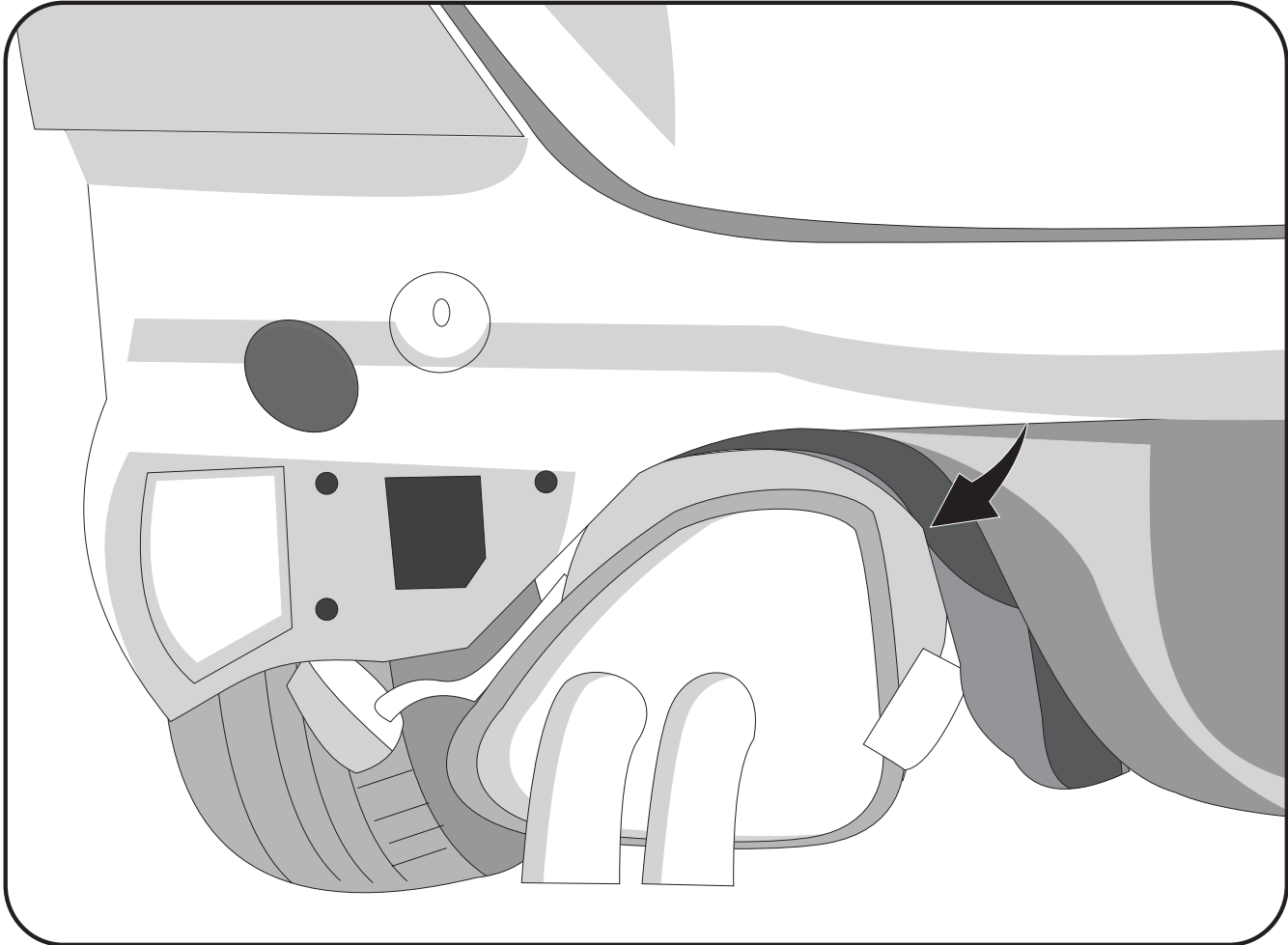
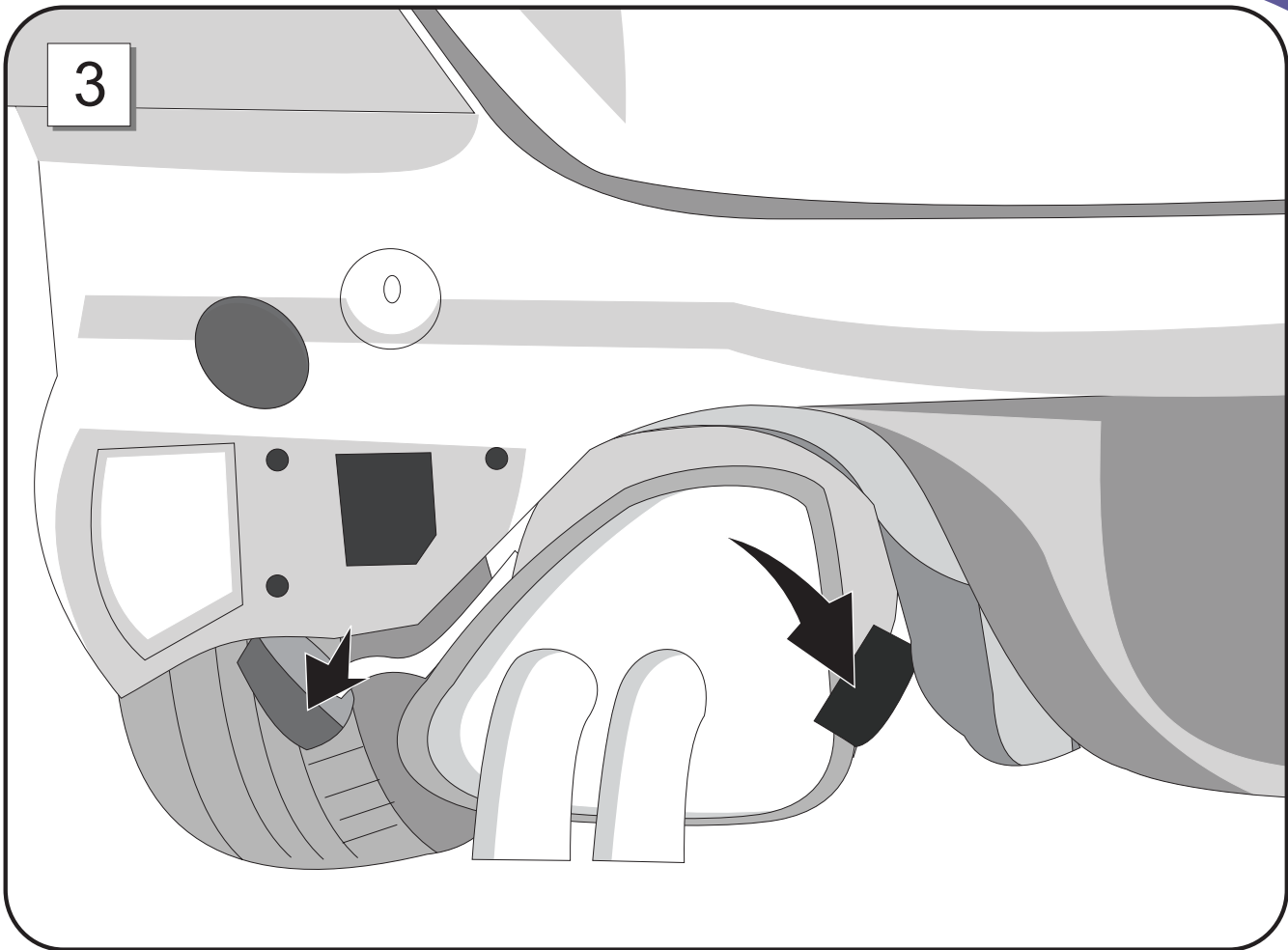

5

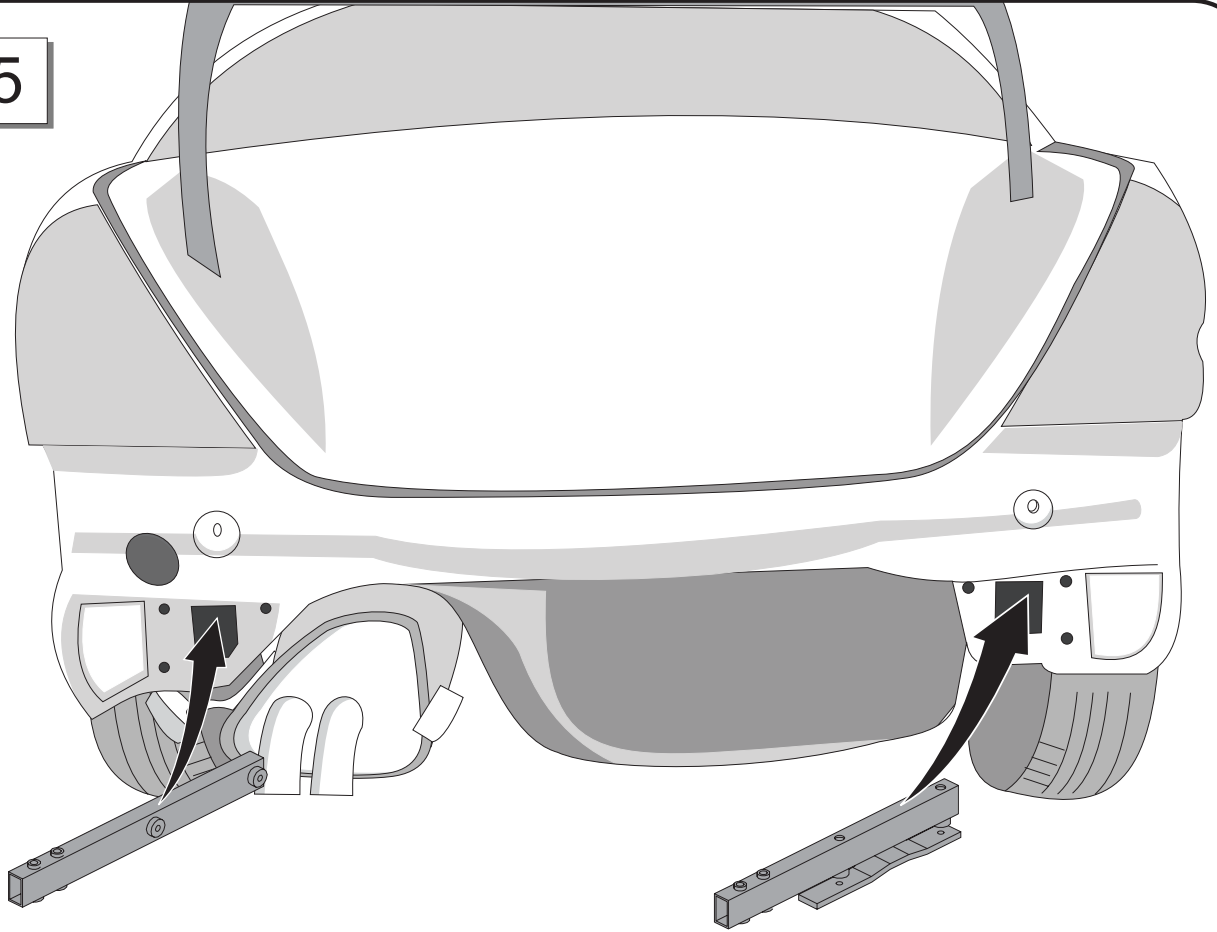

6

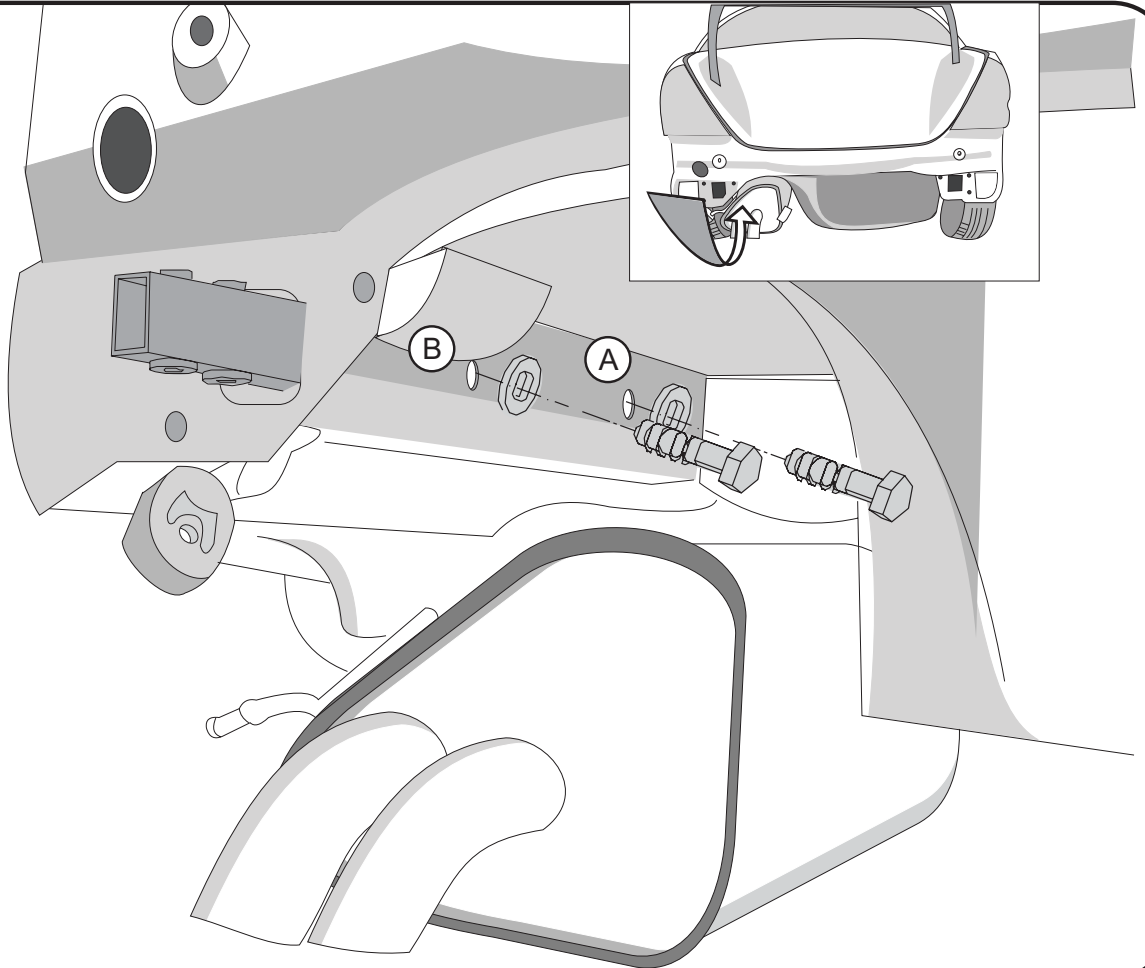

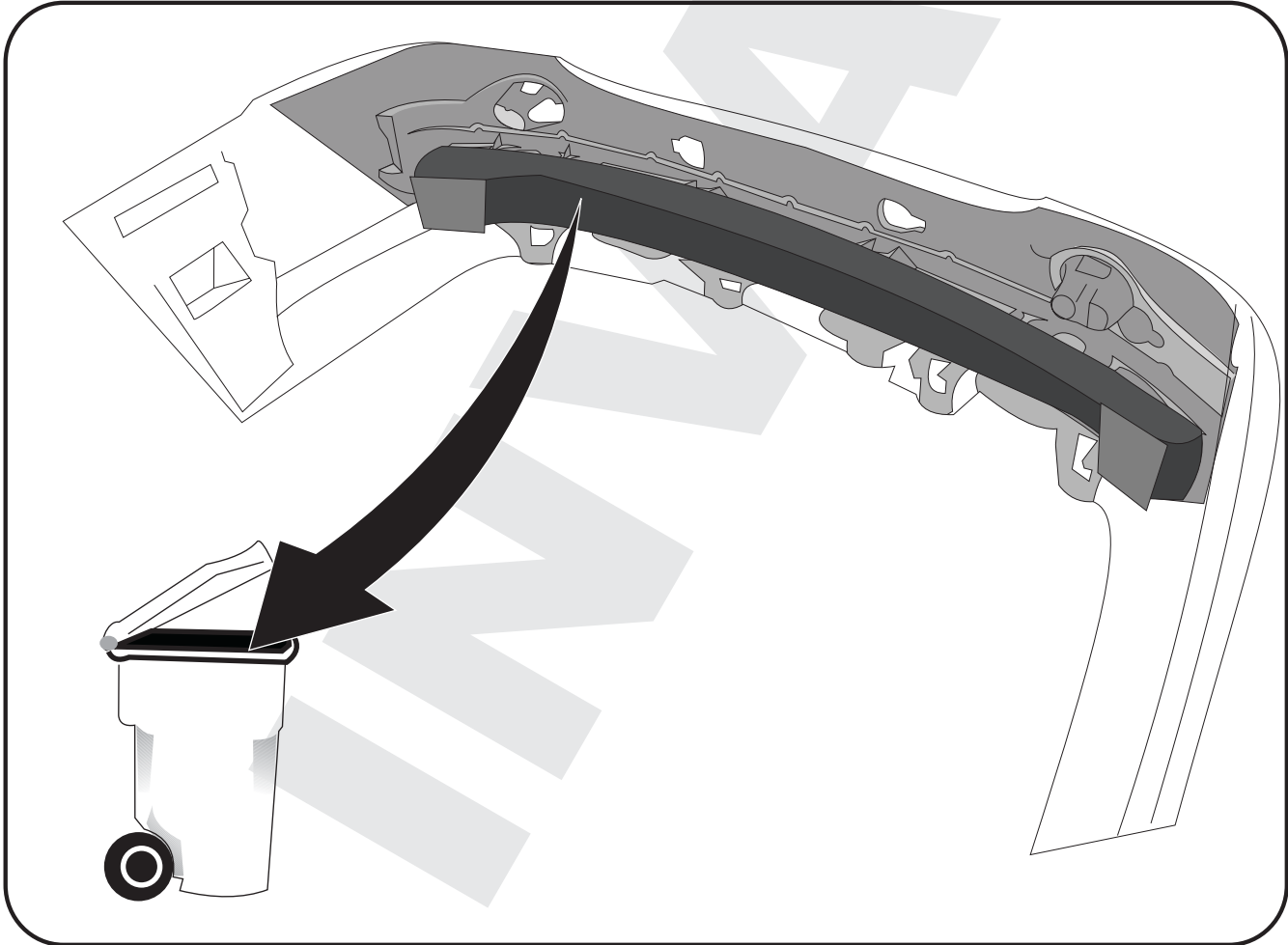
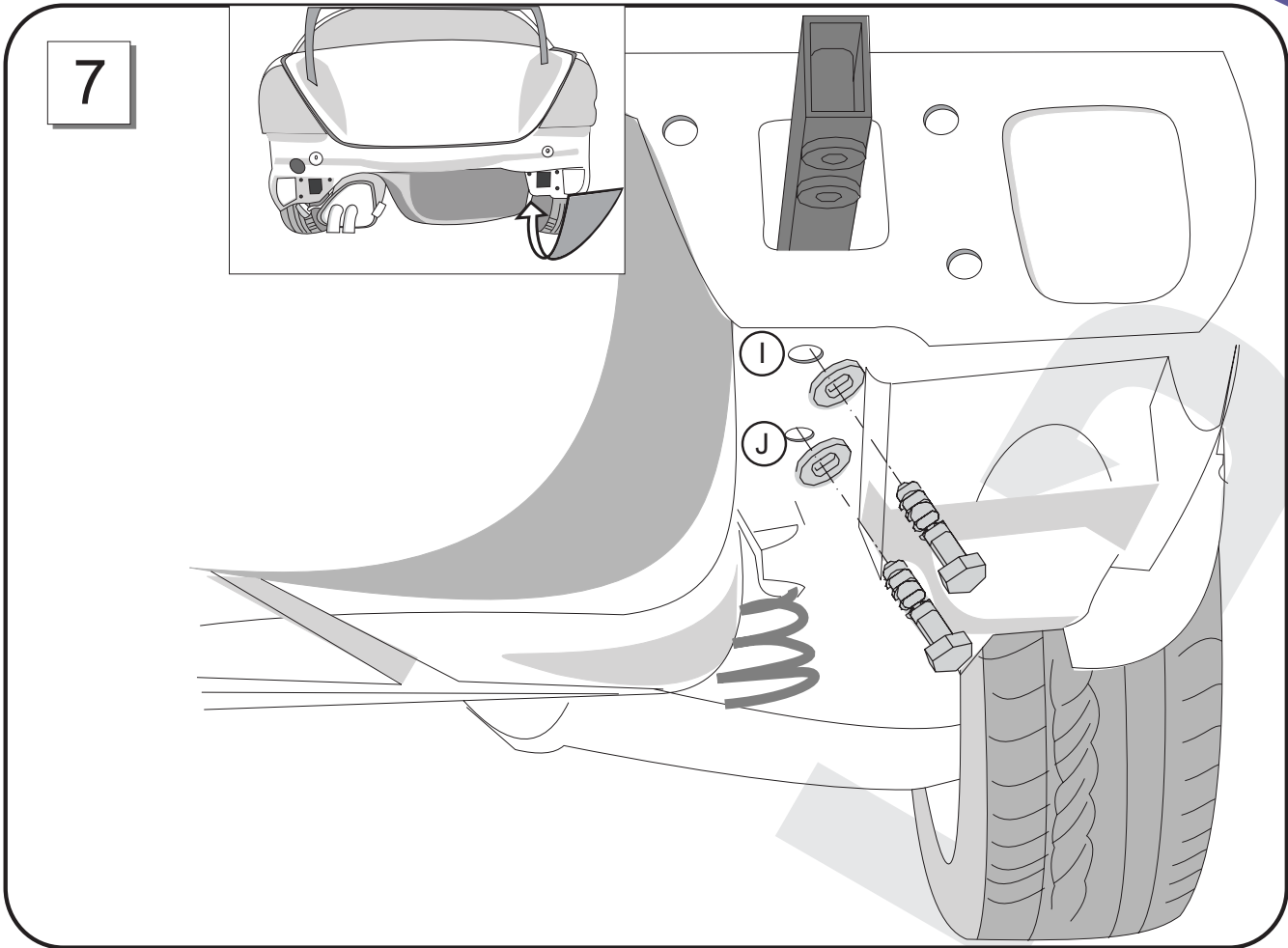

9

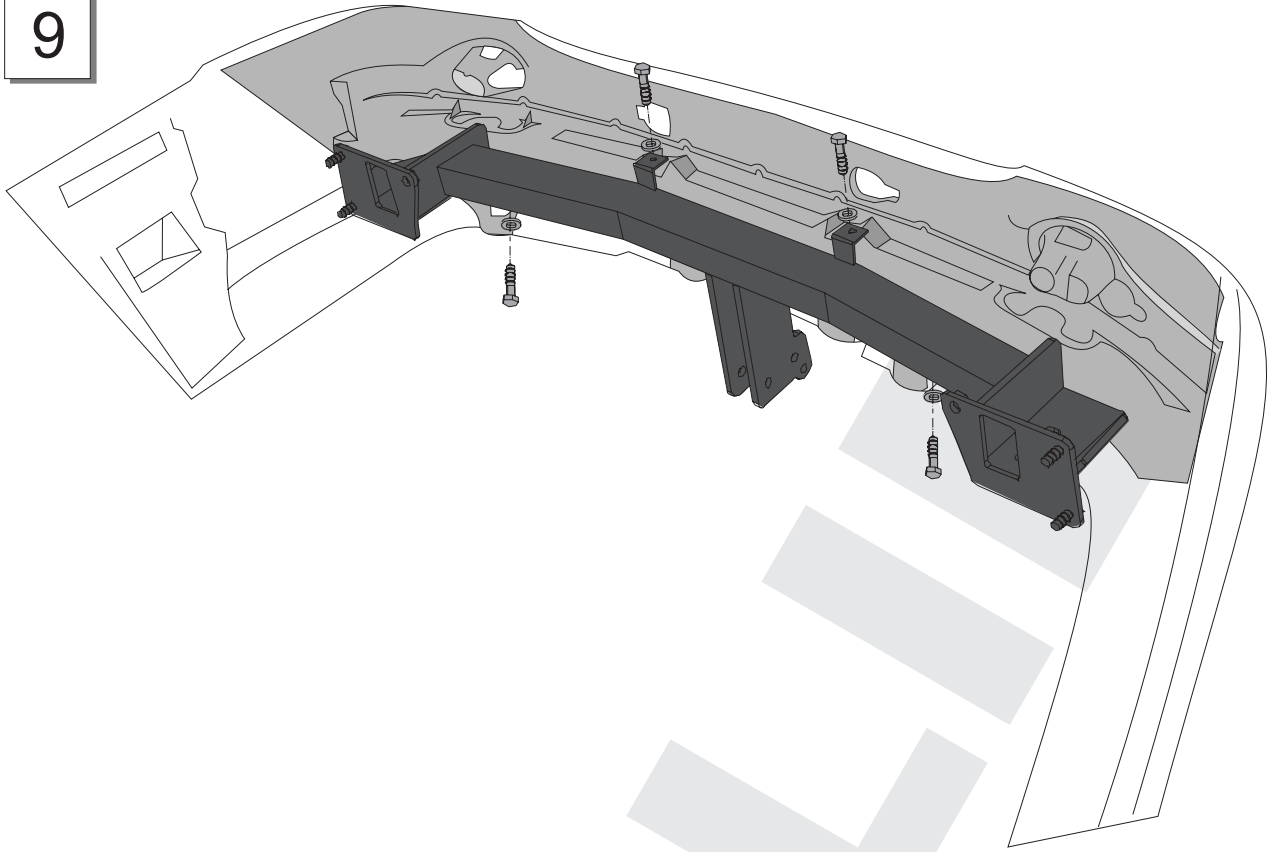

10

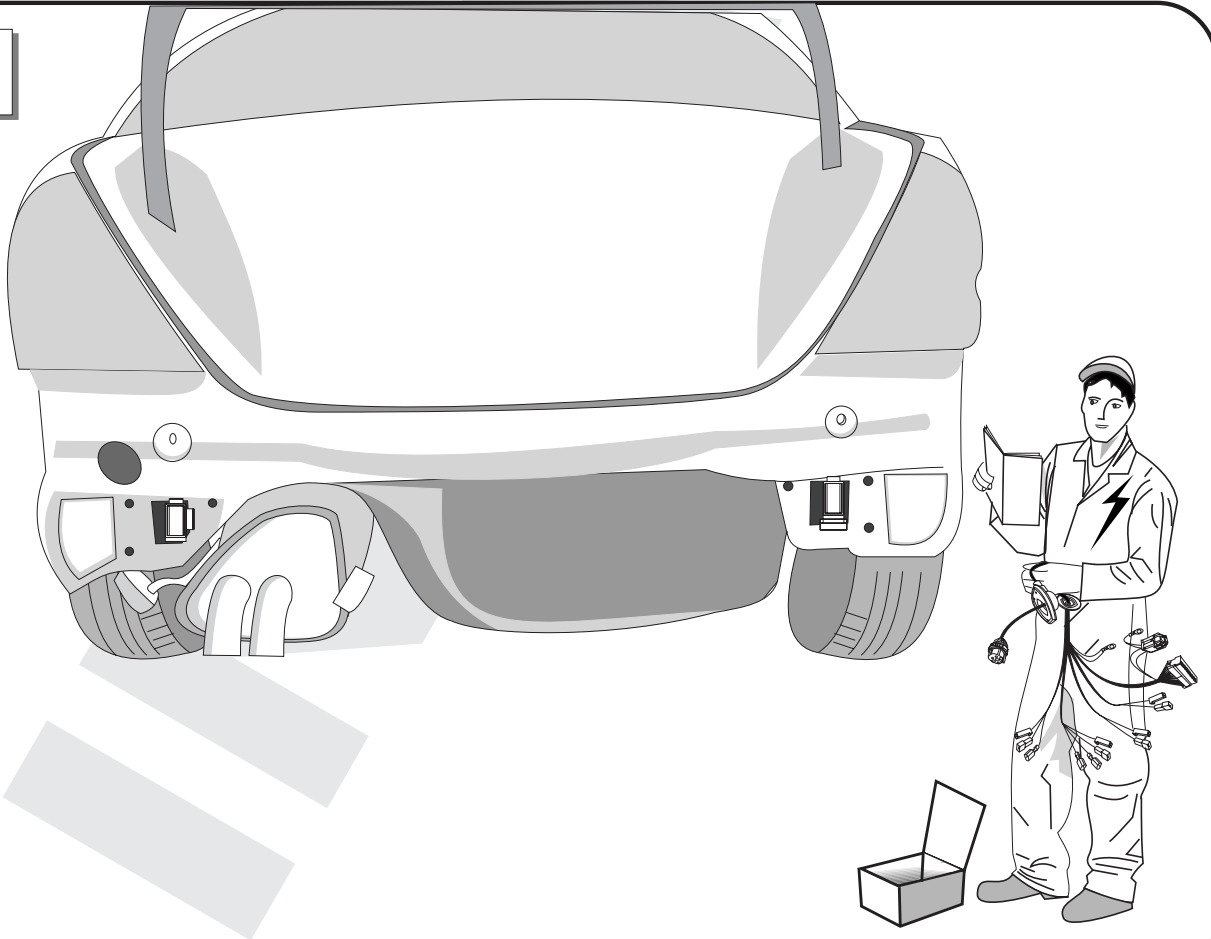

11

URBENi
75 kg

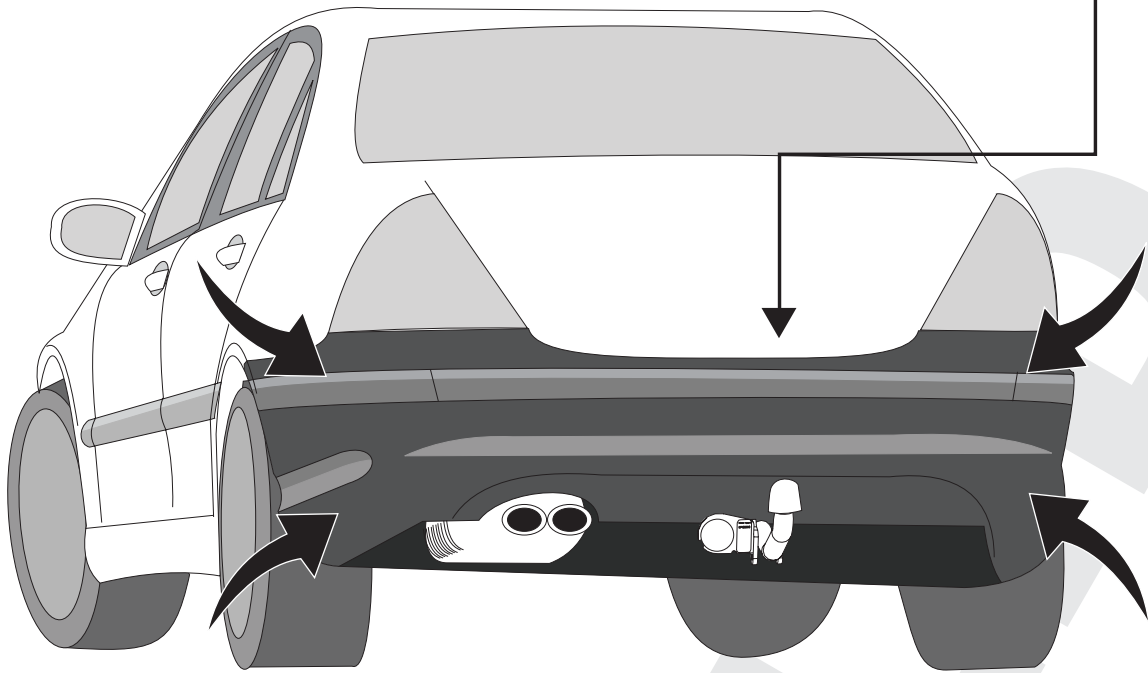

12

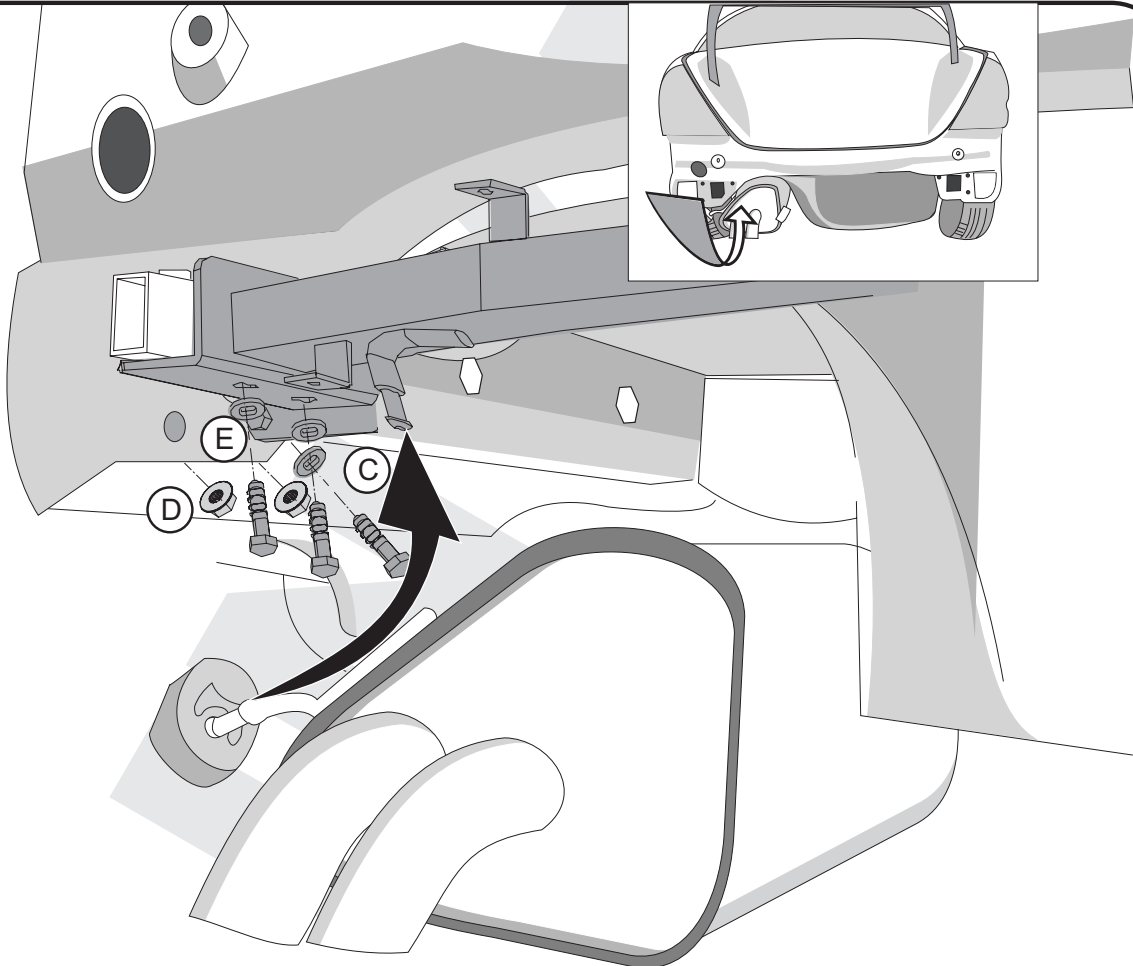

13

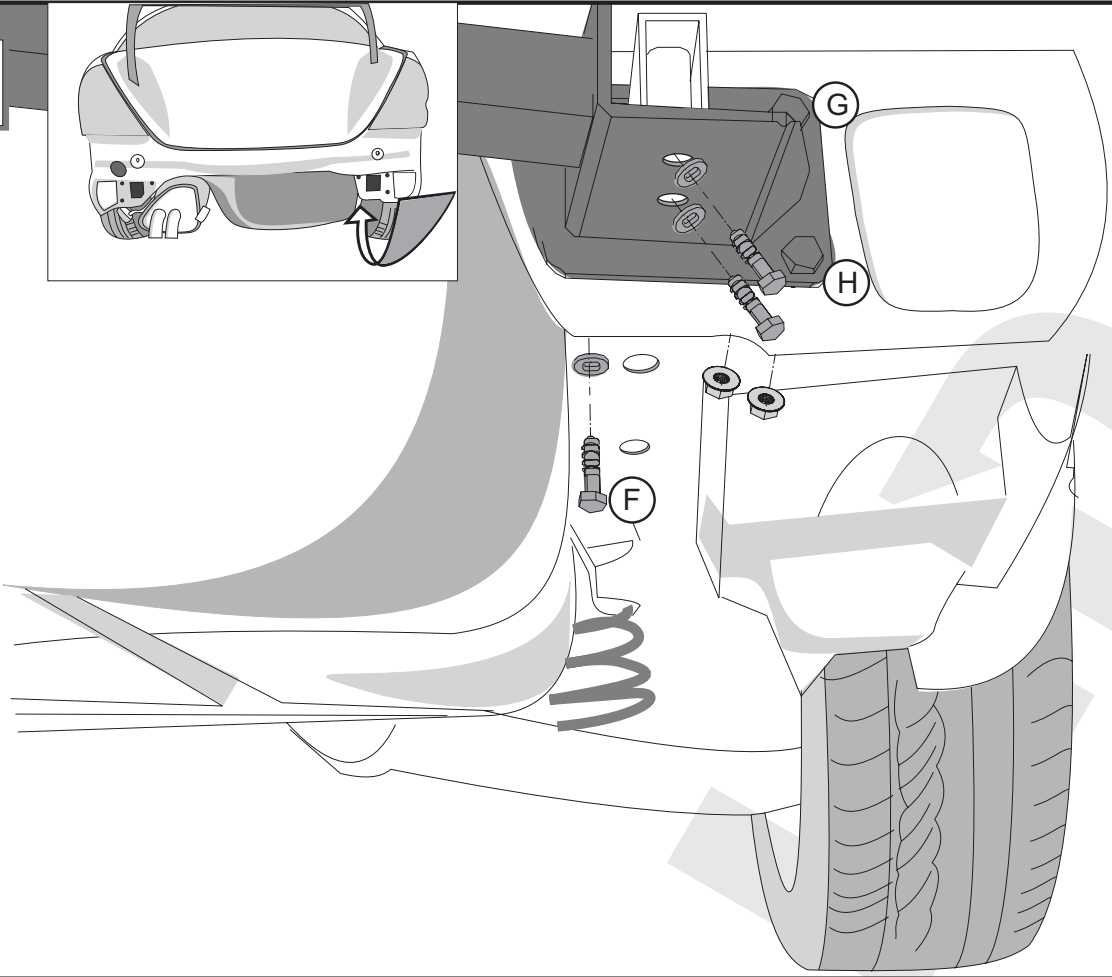
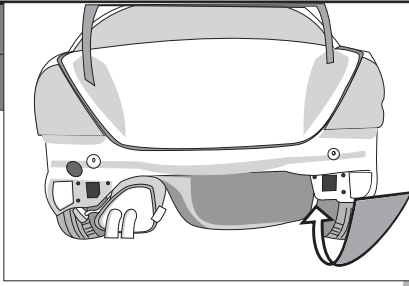

14

E I



NL GR IRL DK
GB F D CZ

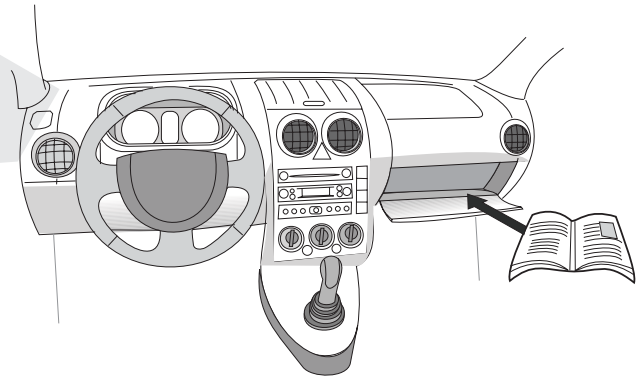
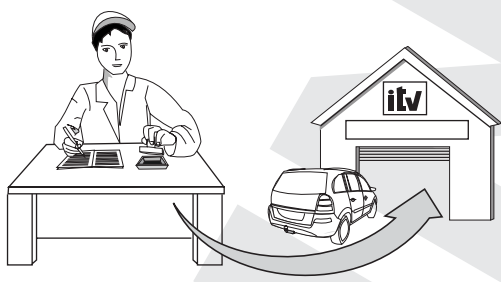

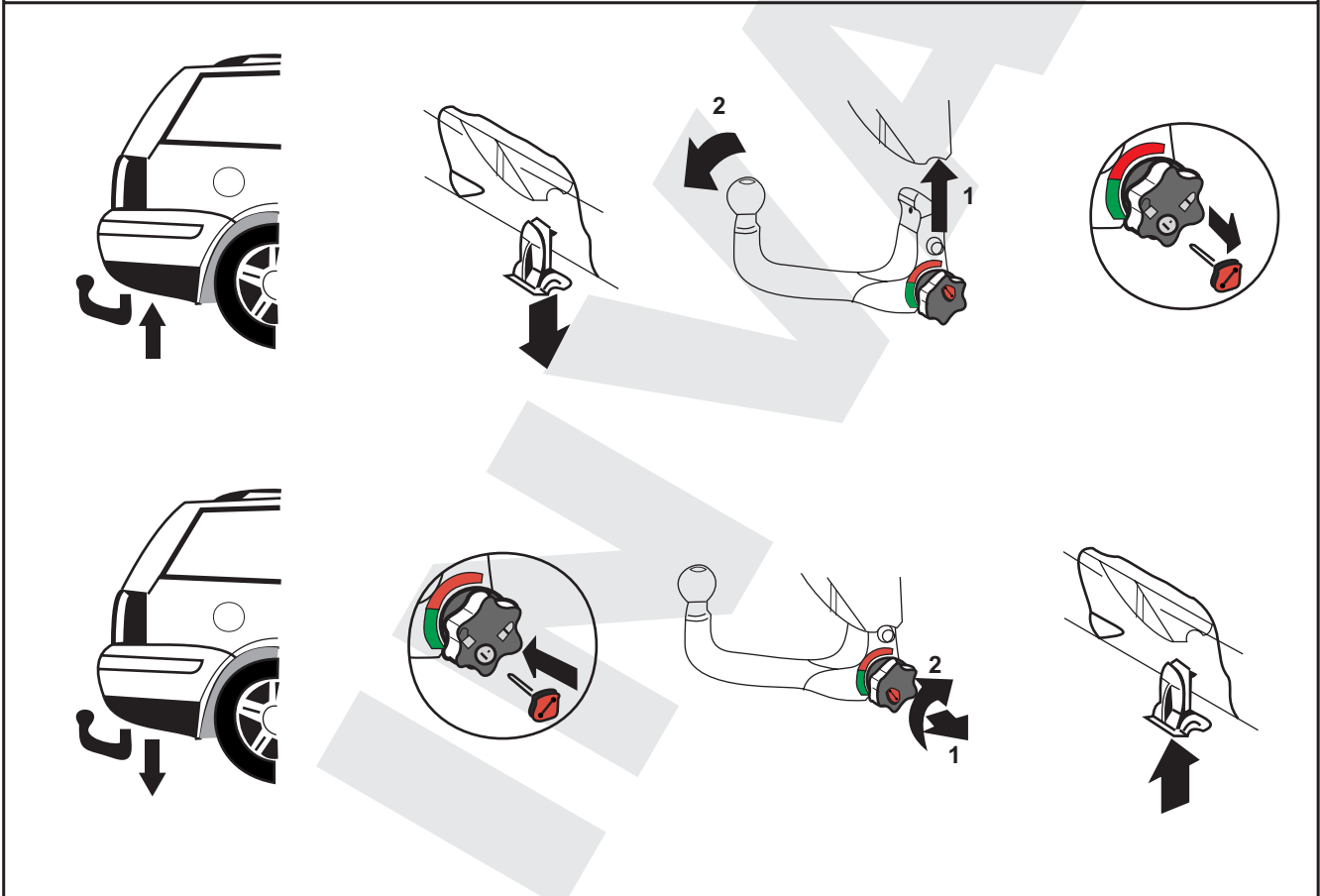
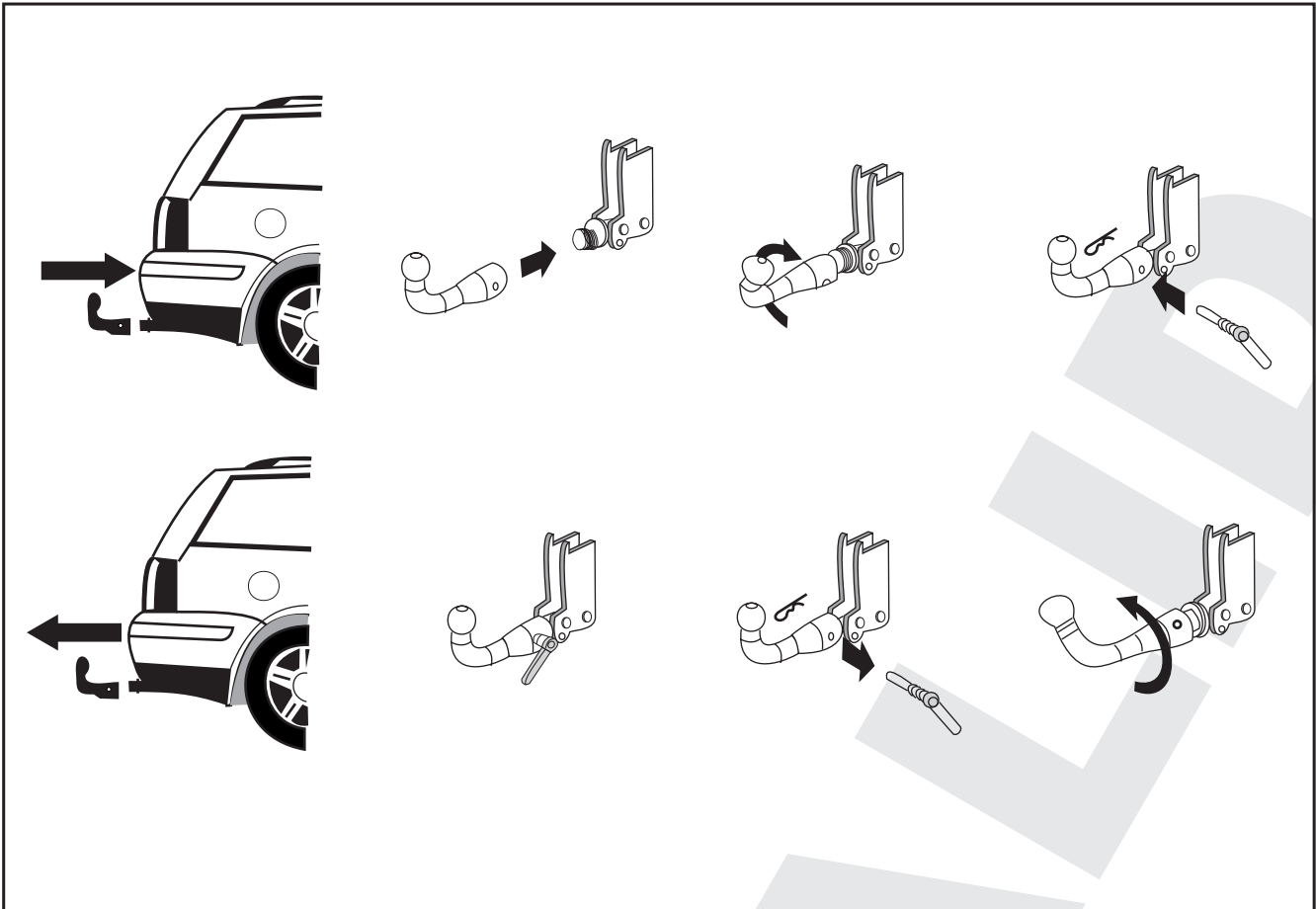

MINISTERE DES TRANSPORTS

Luxemburg, le 30 octobre 2003
19-21, Boulevard Royal
L-2910 LUXEMBOURG
Tél- 478-1 Télécopieur 241817 - Télex 1465 CIVAIR LU

REFERENCE : e13*94/20*94/20*1550*00

ANNEXES : Documentation technique

Certificat de réception CE par type
EC Type-Approval Certificate



Communication concernant ¹
Communication concerning¹

- la réception
the type approval
- l'extension de la réception
the extension of type approval
- le refus de la réception
the refusal of type approval
- le retrait de la réception
the withdrawal of type approval

d'un type d'élément de construction visé par la directive 94/20/CE
of a type of a component with regard to Directive 94/20/EC

Numéro de réception ² :
Type-approval number² :

e13*94/20*94/20*1550*00

Motif de l'extension :
Reason of extension :

Not applicable

SECTION I
SECTION I

0.1. **Marque (raison sociale du constructeur) :**
Make (trade name of manufacturer) :

URBENI

0.2. **Type :**
Type :

M 007

Description(s) commerciale(s) générale(s) :
General commercial description(s) :

Undetachable coupling ball

Version(s)/Variante(s) :
Version(s)/Variant(s) :

Not applicable

0.3. **Moyens d'identification du type, tels que
marqués sur l'élément de construction :**
Means of identification of type if marked on the
component :

See point 0.7.

0.3.1. **Emplacement de ce marquage :**
Location of that marking :

See point 0.7.

MINISTRE DES TRANSPORTS

Luxemburg, le 30 octobre 2003
19-21, Boulevard Royal
L-2910 LUXEMBOURG
Tél- 478-1 Télécopieur 241817 - Télex 1465 CIVAIR LU

REFERENCE: e13*94/20*94/20*1551*00

ANNEXES : Documentation technique

Certificat de réception CE par type
EC Type-Approval Certificate



Communication concernant ¹
Communication concerning¹

- la réception
the type approval
- l'extension de la réception
the extension of type approval
- le refus de la réception
the refusal of type approval
- le retrait de la réception
the withdrawal of type approval

d'un type d'élément de construction visé par la directive 94/20/CE
of a type of a component with regard to Directive 94/20/EC

Numéro de réception ² :
Type-approval number² :

e13*94/20*94/20*1551*00

Motif de l'extension :
Reason of extension :

Not applicable

SECTION I
SECTION I

- 0.1. **Marque (raison sociale du constructeur) :**
Make (trade name of manufacturer) : URBENI
- 0.2. **Type :**
Type : M 008
- Description(s) commerciale(s) générale(s) :**
General commercial description(s) : Detachable coupling ball
- Version(s)/Variante(s) :**
Version(s)/Variant(s) :
-Version B (Detachable coupling ball)
-Version D (Vertical detachable coupling ball)
- 0.3. **Moyens d'identification du type, tels que marqués sur l'élément de construction :**
Means of identification of type if marked on the component : See point 0.7.
- 0.3.1. **Emplacement de ce marquage :**
Location of that marking : See point 0.7.

INVALID

URBENI, S.L.

Pol.Centrovia, A-2, Km 303. c/Buenos Aires, n°10
50196 LA MUELA-ZARAGOZA (ESPAÑA)
Tel.: +34 976 14 44 01 / +34 902 41 78 50
Fax.: +34 976 14 44 02

DA COMPILARE PER IL COLLAUDO

DICHIARAZIONE DI CORETTO MONTAGGIO

La sottoscritta Ditta dichiara di aver montato in maniera corretta ed in conformità alle prescrizioni sia del costruttore del veicolo che del costruttore del dispositivo stesso il seguente dispositivo di attacco meccanico:

Tipo:

Il dispositivo di attacco meccanico sopra descritto è stato installato su autoveicolo tipo:

.....

targa:

.....

Si dichiara inoltre di aver informato l'utente del veicolo sull'USO e MANUTENZIONE del dispositivo stesso.

.....

TIMBRO E FIRMA

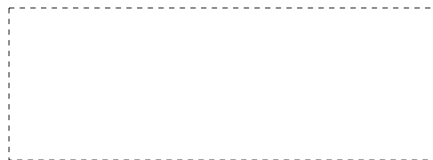

Dispositivo di traino

codice:

Per autoveicoli:

Tipo:

Clase e tipo di attacco:

Omologazione:

Valor D:

Massa Massima

Rimorchiabile:

Carico Verticale Massimo:

Larghezza max.

Rimorquiabile

per Caravan e T.A.T.S.: Vedere CARTA di
CIRCOLAZIONE VEICOLO

(motrice) + 70 cm =.....
arrotondare ai 5 cm superiore

(vedi D.M. 28/05/85)



CERTIFICADO DE MONTAJE

D./Dña., responsable técnico de la empresa....., domiciliada en provincia de, calle nº teléfono, dedicada a la actividad, con nº de Registro Industrial

CERTIFICA

Que la mencionada empresa ha realizado la/s reforma/s consistente/s en: ⁽¹⁾

Incorporación de dispositivo para remolcar, marca:
Con nº de identificaciónmarca de homologación:

Tipificada/s en el Real Decreto 736/1988 con el/los número/s (2) sobre el vehículo marca, tipo, variante denominación comercial, matrícula y nº de bastidor, de acuerdo con:

- La normativa vigente en materia de reformas de importancia de vehículos.
- Las condiciones del informe favorable, o en su caso, las normas del fabricante del vehículo aplicables a la/s reforma/s llevadas a cabo en él.
- El proyecto descriptivo de la/s reforma/s, adjunto al expediente.

OBSERVACIONES:

La reforma efectuada no necesita proyecto según Régimen Transitorio tipificado en el párrafo primero, de la disposición 3ª de la página 44.034 del B.O.E. nº 301 de fecha de publicación 17 de diciembre de 2002

_____ a _____ de _____ de _____

Firma y Sello

Fdo, el responsable técnico.: _____

⁽¹⁾ Se describirán las operaciones básicas realizadas sobre el vehículo y se citarán los elementos y sistemas instalados.

⁽²⁾ Si el dispositivo para remolcar no cumple con la normativa 94/20/CE poner "26"
Si el dispositivo para remolcar cumple con la normativa 94/20/CE dejar en blanco y proceder a la anotación en la tarjeta ITV adjuntando el certificado de montaje del taller y el manual de instrucciones de montaje.

